

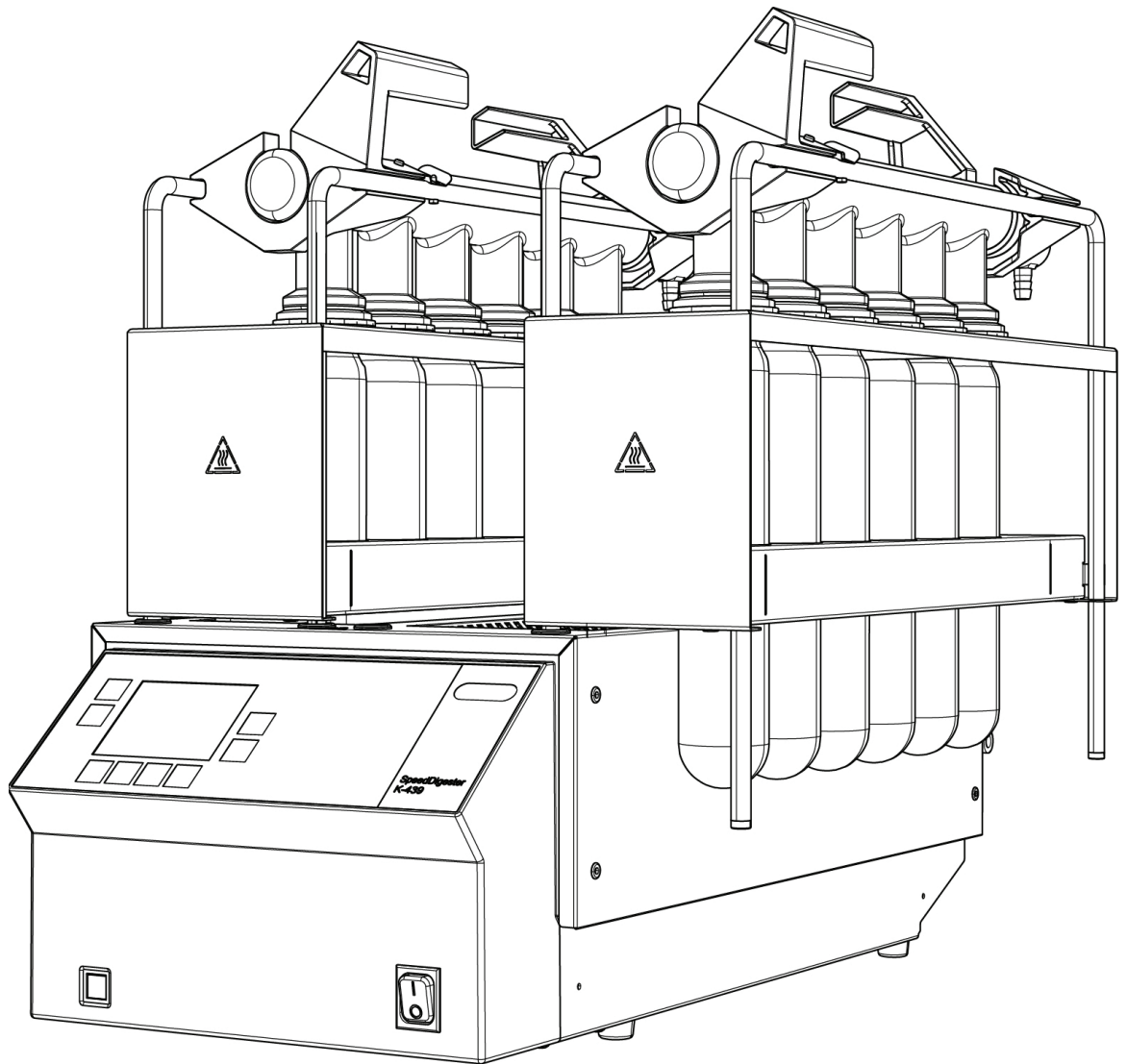

SpeedDigester K-439

Operation Manual



Imprint

Product Identification:
Operation Manual (Original), SpeedDigester K-439

11593351B en

Publication date:
10.2019, Version B

BÜCHI Labortechnik AG
Meierseggstrasse 40
Postfach
CH-9230 Flawil 1

E-Mail: quality@buchi.com

BUCHI reserves the right to make changes to the manual as deemed necessary in the light of experience; especially in respect to structure, illustrations and technical detail.

This manual is copyright. Information from it may not be reproduced, distributed, or used for competitive purposes, nor made available to third parties. The manufacture of any component with the aid of this manual without prior written agreement is also prohibited.

Table of contents

1	About this manual	5
2	Safety.	6
2.1	User qualification	6
2.2	Proper use	6
2.3	Improper use	6
2.4	Safety warnings and safety signs used in this manual	7
2.5	Product safety.	9
2.5.1	General hazards.	9
2.5.2	Warning labels on housing and assemblies	11
2.5.3	Personal protective equipment	11
2.5.4	Built-in safety elements and measures	12
2.6	General safety rules	12
3	Technical data	13
3.1	Scope of application and delivery	13
3.1.1	Available system configurations	13
3.1.2	Accessories for 300ml sample tubes (for standard applications)	14
3.1.3	Accessories for 500ml sample tubes (for large sample volumes / at low nitrogen level)	14
3.1.4	Accessories for 3rd party production, 250ml sample tubes	15
3.2	Technical data.	16
3.3	Materials used.	17
4	Description of function	18
4.1	Functional principle	18
5	Putting into operation	19
5.1	Installation site.	19
5.2	System fixation	20
5.3	Electrical connections	21
5.3.1	SpeedDigester connection	21
5.3.2	Scrubber/water jet pump connection	21
6	Operation	22
6.1	Operating controls and housing	22
6.1.1	SpeedDigester K-439 — front side	22
6.1.2	System rear side	23
6.2	User interface	24
6.3	Program structure overview	25
6.4	Software buttons	26
6.5	Software icons	27
6.5.1	General icons (used in automatic and manual mode)	27
6.5.2	Icons in automatic mode	27
6.5.3	Icons in manual mode.	27
6.6	How to prepare the software for routine digestion	28
6.6.1	Standard instrument settings	28
6.6.2	Digestion in Manual Mode.	29
6.6.3	Methods menu	30
6.6.4	Digestion in Automatic Mode	35
6.6.5	History menu	36
6.7	Preparing of SpeedDigester, suction module(s) and sample tubes.	36

6.7.1	Kjeldahl digestion —preparing sample tubes	37
6.7.2	Peroxide digestion —preparing sample tubes	38
6.7.3	Installing a suction module and sample tubes (300 ml).	39
6.7.4	Installing 500 ml sample tubes.	41
6.7.5	Starting up the SpeedDigester	43
6.8	Performing a Kjeldahl digestion process.	43
6.8.1	Preparational steps	43
6.8.2	Starting a digestion process.	43
6.9	Performing a peroxide digestion process	44
6.9.1	Preparational steps	44
6.9.2	Starting a digestion process.	44
6.10	Finishing a digestion process	46
6.11	Optional 'Stand with drip tray'.	49
7	Maintenance and repairs	50
7.1	Customer service	51
7.2	General condition and cleaning instructions	51
7.2.1	Breakage of glassware inside a housing chamber	52
7.2.2	Liquid ingress into the instrument	52
7.3	Glass component conditions	53
7.3.1	Sample tubes	53
7.4	Sealing system	53
7.5	Rack system	54
7.5.1	300 ml sample tube support spring	54
7.5.2	500 ml sample tube support spring	55
7.6	Display cover	55
8	Troubleshooting	56
8.1	Malfunctions and their remedy.	56
8.2	Diagnostics	57
8.2.1	Actors.	57
8.2.2	Sensors	58
8.2.3	Operating Hours.	58
8.2.4	Unit Information	58
8.2.5	Service Test	58
8.3	Device fuses.	59
9	Shutdown, storage, transport and disposal	60
9.1	Storage and transport.	60
9.2	Disposal.	61
10	Spare parts.	63
10.1	Spare parts, optional accessories and consumables	63
11	Declarations and requirements.	66
11.1	FCC requirements (for USA and Canada)	66

1 About this manual

This manual describes the SpeedDigester K-439 and provides all information required for its safe operation and to maintain it in good working order.

It is addressed to laboratory personnel and operators in particular.

Read this manual carefully before installing and running your system and note the safety precautions in chapter 2 in particular. Store the manual in the immediate vicinity of the instrument, so that it can be consulted at any time.

No technical modifications may be made to the instrument without the prior written agreement of Buchi. Unauthorized modifications may affect the system safety or result in accidents. Technical data are subject to change without notice.

NOTE

The symbols pertaining to safety (WARNINGS and ATTENTIONS) are explained in chapter 2.

This manual is copyright. Information from it may not be reproduced, distributed or used for competitive purposes, nor made available to third parties. The manufacture of any component with the aid of this manual without prior written agreement is also prohibited.

The English manual is the original language version and serves as basis for all translations into other languages. If you need another language version of this manual, you can download available versions at www.buchi.com.

2 Safety

This chapter introduces the safety concept of the instrument and contains general rules of behavior and warnings from direct and indirect hazards concerning the use of the product.

For the users safety, all safety instructions and safety messages in the individual chapters shall be strictly observed and followed. Therefore, the manual must always be available to all persons performing any tasks described herein.

2.1 User qualification

The instrument may only be used by laboratory personnel and other persons who on account of training and professional experience know the potential dangers that can develop when operating the instrument.

Untrained personnel, or persons who are currently being trained, require careful supervision by a qualified person. Operation Manual serves as a basis for training.

2.2 Proper use

The SpeedDigester K-439 has been designed and built for laboratory use only. Its intended use is to allow digestion of samples with concentrated acids or peroxides by heating up the probe.

A suction unit (e.g. Scrubber or water jet pump) has to be connected to the suction module to safely withdraw fumes which will emerge during digestion. In any case, all exhausts and fumes leaving the system or assemblies such as Scrubber or water jet pump have to be removed instantly inside a fume hood. This is mandatory to remove all possibly hazardous substances (e.g. acid fumes) from the working area. The ventilation system of the fume hood has to be equipped with safety measures such as outlet filters to avoid contamination of the environment.

When the SpeedDigester K-439 is used in combination with other instruments (e.g. Scrubber and fume hood) all related manuals are to be fully observed.

2.3 Improper use

Applications not mentioned in section 2.2 are considered to be improper. Applications which do not comply with the technical data (see section 3 of this manual) are also considered to be improper.

The operator bears the sole risk for any damages or hazards caused by improper use!



The following uses are expressly forbidden:

- Digestion operations outside an active fume hood.
- Digestion of samples (e.g. food and feed) in nitrosulfuric acids which can produce explosive nitro compounds.
- Digestion of sample material of unknown composition in nitrosulfuric acids.
- Use of samples which can explode or ignite due to shocks, friction, heat or sparks.
- Installation or use of the instrument in rooms, which require ex-protected instruments.
- Use of glassware which is not specified in section 2.5.4.

2.4 Safety warnings and safety signs used in this manual

DANGER, WARNING, CAUTION and NOTICE are standardized signal words for identifying levels of hazard seriousness of risks related to personal injury and property damage. All signal words, which are related to personal injury are accompanied by the general safety sign.

For your safety it is important to read and fully understand the table below with the different signal words and their definitions!

Sign	Signal word	Definition	Risk level
	DANGER	Indicates a hazardous situation which, if not avoided, will result in death or serious injury.	★★★★★
	WARNING	Indicates a hazardous situation which, if not avoided, could result in death or serious injury.	★★★★☆
	CAUTION	Indicates a hazardous situation which, if not avoided, may result in minor or moderate injury.	★★★☆☆
no	NOTICE	Indicates possible property damage, but no practices related to personal injury.	★☆☆☆☆ (property damage only)

Supplementary safety information symbols may be placed in a rectangular panel on the left to the signal word and the supplementary text (see below example).

















Space for supplementary safety information symbols.	 SIGNAL WORD
	Supplementary text, describing the kind and level of hazard / risk seriousness. <ul style="list-style-type: none"> List of measures to avoid the herein described, hazard or hazardous situation.

Table of supplementary safety information symbols

The reference list below incorporates all safety information symbols used in this manual and their meaning.

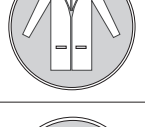
Symbol	Meaning
	General warning
	Electrical hazard
	Heavy weight, avoid overexertion

Symbol	Meaning
	Explosive gases, explosive environment
	Explosive material
	Fire hazard
	Harmful to life-forms
	Hot item, hot surface
	Device damage
	Inhalation of substances
	Chemical burns by corrosives
	Fragile components
	Wear laboratory coat
	Wear protective goggles

Symbol	Meaning
	Wear protective gloves
	Heavy weight, lifting requires more than one person

Additional user information

Paragraphs starting with Note transport helpful information for working with the device/software or its supplementaries. Notes are not related to any kind of hazard or damage (see following example).

Note

Useful tips for the easy operation of the instrument/software.

2.5 Product safety



The SpeedDigester K-439 has been designed and built in accordance with current state-of-the-art technology. Safety warnings in this manual (as described in section 2.4) serve to make the user alert to and avoid hazardous situations emanating from residual dangers by giving appropriate counter measures.







However, risks to users, property and the environment can arise when the instrument is damaged, used carelessly or improperly.

2.5.1 General hazards

The following safety messages show hazards of general kind which may occur when handling the instrument. The user shall observe all listed counter measures in order to achieve and maintain the lowest possible level of hazard.



Additional warning messages can be found whenever actions and situations described in this manual are related to situational hazards.

 	 DANGER
	<p>Death or serious injuries by use in explosive environments.</p> <ul style="list-style-type: none"> • Do not store or operate the instrument in explosive environments • Do not store chemicals in the vicinity of the device • Operate the device in a fume hood with sufficient ventilation to directly withdraw fumes

	<p>! WARNING</p> <p>Death or serious burns by flammable vapors.</p> <ul style="list-style-type: none"> • Remove all sources of flammable vapors • Do not store flammable chemicals in the vicinity of the device
  	<p>! WARNING</p> <p>Risk of death or serious chemical burns by hot acid or peroxide fumes.</p> <ul style="list-style-type: none"> • Do not operate the system with faulty parts • Check instrument setup for proper sealing before use • Do not inhale process fumes • Operate the instrument inside an active fume hood • Do not move the instrument or parts of it during digestion
	<p>! CAUTION</p> <p>Risk of minor or moderate cuts by sharp edges.</p> <ul style="list-style-type: none"> • Do not touch defective or broken glassware with bare hands • Do not touch thin metal edges
	<p>! CAUTION</p> <p>Risk of burns by hot machine parts and glassware.</p> <ul style="list-style-type: none"> • Do not touch hot parts or surfaces • Let the system and inserted glassware cool down safely • Do not move the instrument or parts of it when hot
	<p>NOTICE</p> <p>Risk of instrument damage by liquids or mechanical shocks.</p> <ul style="list-style-type: none"> • Do not spill liquids over the instrument or its components • Do not move the instrument when it is loaded with sample liquid • Do not drop the instrument or its components • Keep external vibrations away from the instrument • Safely attach the instrument to the bench in earthquake prone regions • Do not operate the instrument without the display cover installed





2.5.2 Warning labels on housing and assemblies

The following warning sticker(s) can be found on the housing or assemblies of the SpeedDigester:

Symbol	Meaning	Location
	Hot item, hot surface	Sticker / label, located on top of the housing and at the racks
	Do NOT put rack into side cooling position	Label on 500 ml racks

2.5.3 Personal protective equipment

Always wear personal protective equipment such as protective eye goggles, protective clothing and gloves. The personal protective equipment must meet all requirements of the supplementary data sheets for the chemicals used.

 WARNING	
   	<p>Serious chemical burns by corrosives.</p> <ul style="list-style-type: none"> • Observe supplementary data sheets of all used chemicals. • Handle corrosives in well ventilated environments only. • Always wear protective goggles. • Always wear protective gloves. • Always wear protective clothes. • Do not use damaged glassware.

2.5.4 Built-in safety elements and measures

Buchi glassware design

- All original Buchi digestion glassparts are made of high temperature and chemical resistant borosilicate glass.
- Acid fumes generated during digestion accumulate in the suction module
- The fumes must be safely withdrawn from the suction module via one or more hoses to a Scrubber (e.g. Scrubber B-414) or via water jet pump into a sink or sufficient suction flow.

3rd party glassware

The quality of the material is an essential part of the safety concept of the SpeedDigester K-439. For the special rack (order no. 11055440), the following qualified vendors offer sample tubes of sufficient quality grade to withstand the temperatures and the aggressive chemical digestion agents:

Qualified vendor	Tested sample tube(s)
Gerhardt	250 ml / 6100
Velp	∅ 42×300 mm / A00000144
Foss	250 ml / 10014278

Heater

Each heating chamber is equipped with a safety overtemperature switch. In case of an emergency the switch cuts off the power of the corresponding chamber.

2.6 General safety rules

Responsibility of the operator

The head of the laboratory is responsible for training his/her personnel.

The operator shall inform the manufacturer without delay of any safety-related incidents which might occur during operation of the instrument or its accessories. Legal regulations, such as local, state and federal laws applying to the instrument or its accessories must be strictly followed.

Duty of maintenance and care

The operator is responsible for the proper condition of instrument. This includes maintenance, service and repair jobs that are performed on schedule by authorized personnel only.

Spare parts to be used

Use only genuine consumables and spare parts for maintenance to assure good system performance, reliability and safety. Any modifications of spare parts or assemblies are only allowed with the prior written permission of the manufacturer.

Modifications

Modifications to the instrument are only permitted after prior consultation and with the written approval of the manufacturer. Modifications and upgrades shall only be carried out by an authorized Buchi technical engineer. The manufacturer will decline any claim resulting from unauthorized modifications.

3 Technical data

This chapter introduces the reader to the SpeedDigerster K-439 and its specifications. It contains the scope of delivery, technical data, requirements and performance data.

3.1 Scope of application and delivery

All system configurations come with a limited set of accessories as a starter kit. Within a system family, additionally available accessories (see section 3.1.2 and the following) can be used to easily reconfigure your system to every configuration listed in section 3.1.1.

Parts that are required to change a system configuration:

- Rack
- Suction module
- Insulation plate (fireclay insert)
- Sample tubes

The scope of delivery depends on the ordered system configuration and can be checked according to the individual delivery note and the listed order numbers.

Note

For additional information about the listed products, see www.buchi.com or contact your local dealer.

3.1.1 Available system configurations

Configuration order number	Sample positions		Sample tube sizes			Suction modules			
	5	6	250 ml	300 ml	500 ml	Standard	Condensate trap	H ₂ O ₂	Module for 3rd party tubes
220–240V	5	6	250 ml	300 ml	500 ml	Standard	Condensate trap	H ₂ O ₂	Module for 3rd party tubes
1154392500	●				●		●		
1154392100		●		●		●			
1154392200		●		●			●		
1154392300		●		●				●	
1154392400		●	●*						●*

* Third party sample tubes require special accessories such as the BUCHI “Module for 3rd party tubes” and the matching rack/insulation plate. Tubes are not included in the set!

3.1.2 Accessories for 300 ml sample tubes (for standard applications)

Item	Additional info	Order number	Recommended quantity to order
Set of sample tubes	300 ml, 4 tubes	037377	3x
Suction module standard	6 place	11055849	2x
Suction module condensate trap	6 place	11055865	2x
Suction module H ₂ O ₂	6 place, cpl.	11055853	2x
Connectors to suction module	Adapter and plug	11055367	2x
EPDM hose set	Hoses and t-piece	11056219	1x
Insulation plate (fireclay)	Insertion, for 300 ml tubes	11055142	2x
Rack	6 place, for 300 ml tubes	11055248	2x
Glass caps (set of 4)	OPTIONAL	040049	—
Insulation cap	OPTIONAL	11056024	—
Sealing FKM (set of 6)	Spare part	038122	—
Sealing PTFE (1 pcs)	OPTIONAL	022442	—
Rubber GUKOs for H ₂ O ₂ suc. mod.	Spare part set of 6	044495	—
Filter funnel for H ₂ O ₂ suc. mod.	Spare part set of 6	044494	—
Set circular spring and holder	Spare part set of 6	11055984	—
Bed-plate for 300ml racks	OPTIONAL	11055943	—

3.1.3 Accessories for 500 ml sample tubes (for large sample volumes / at low nitrogen level)

Standard items	Additional info	Order number	Recommended quantity to order
Sample tubes	500 ml, single tube	026128	10x
Set of sample tubes	500 ml, 4 tubes	043982	3x
Suction module condensate trap	5 place	11055851	2x
Connectors to suction module	Adapter and plug	11055367	2x
EPDM hose set	Hoses and t-piece	11056219	1x
Insulation plate (fireclay)	Insertion, for 500 ml tubes	11055143	2x
Rack	5 place, for 500 ml tubes	11055327	2x
Base for rack	For 500 ml tubes rack	11055612	1x
Glass caps (set of 4)	OPTIONAL	040049	—
Insulation cap	OPTIONAL	11056024	—
Sealing FKM (set of 6)	Spare part	038122	—
Sealing PTFE (1 pcs)	OPTIONAL	022442	—
Interlock spring for 500 ml rack	Spare part	11055385	—

3.1.4 Accessories for 3rd party production, 250 ml sample tubes

Item	Additional info	Order number	Recommended quantity to order
3rd party sample tubes	250 ml	n.a.	12x
Suction module for 3rd party tubes	6 place	11055850	2x
Connectors to suction module	Adapter and plug	11055367	2x
EPDM hose set	Hoses and t-piece	11056219	1x
Insulation plate (fireclay)	Insertion, for 250 ml tubes	11055877	2x
Rack	6 place, for 250 ml tubes	11055440	2x
Sealing FKM (set of 6)	Spare part	038125	—
Set circular spring and holder 6×	OPTIONAL	11055985	—

Note

Tested 3rd party sample tubes (listed in section 2.5.4) are not available at Buchi. Please contact your local OEM vendor for these type of tubes.

3.2 Technical data

The table below lists all main design parameters of the SpeedDigester K-439.

Technical data	
Power consumption	max. 2000 W
Temperature control range	50 – 580 °C
Temperature accuracy	± 5 K at 200 °C / ± 10 K at 550 °C
Connection voltage	220 – 240 VAC
Frequency	50 / 60 Hz
Input fuse	T 10A L 250V
Scrubber output	max. 0,7A
Display	QVGA 240×320 pixels
IP degree of protection (two digits)	IP 20
	Explanation of protection level:
	2 Protection provided by the enclosure against access to hazardous parts (e.g., electrical conductors, moving parts) and the ingress of solid foreign objects with a diameter of > 12,5 mm.
	0 No protection of the equipment inside the enclosure against harmful ingress of water.
Insulation category	II
Environmental conditions:	
Pollution degree	2 (for indoor use only)
Temperature	5 – 40 °C
Altitude (above sea level)	up to 2000 m
Humidity (curve parameter)	Maximum relative humidity 80% up to 31 °C, then decreasing linearly to 50% relative humidity at 40 °C
Dimensions in mm (W × D × H)	310 × 620 × 540
Net weight	15,5 kg
Rack	2,5 kg (per rack)

Note

The SpeedDigester K-439 is suited to work with an input power range of 220 V to 240 V mains voltage. Check your local voltage requirements prior to installation!

3.3 Materials used

Materials used		
Component	Material designation	Material code
Stainless steel	Housing	
	Heating chamber	
	Heating element	
	Rack	
	Hose clamp	
Silicic acid	Heating chamber	SiO ₂ , SiC
Ceramic fiber felt	Heating chamber	
Calcium silicate	Insulation plate	
Phlogopite mica	Preheat cover	
Plastic	Front hood	PBT
	Front panel under keypad	PP
	Display cover	PVC
	Suction hoses	EPDM
	Drip tray	PP
	Rack	PPS
	Sealings suction tube	FKM/PFE
	Hose coupling	PP
Borosilicate glass 3.3	Protective glass display	
	Digestion tubes	
	Suction tube	
Aluminium	Front bottom	
	Heat sink front	

4 Description of function

This chapter explains the basic working principle of the SpeedDigester K-439. It also shows how the instrument is structured and provides a general functional description of its assemblies.

4.1 Functional principle

The SpeedDigester K-439 is a special heating device to digest samples. It can generate max. temperatures of 580 °C. This allows e.g. acid digestion of organic sample components in a concentrated sulfuric acid/catalyst mixture, known as 'Kjeldahl digestion'. During the processing the sample material can reach peak temperatures of up to 370 °C at the bottom area of the sample tubes. The maximum temperature of the sample highly depends on its composition i.e. the ratio of catalyst to acid and can change during the digestion process.

Digestion process overview

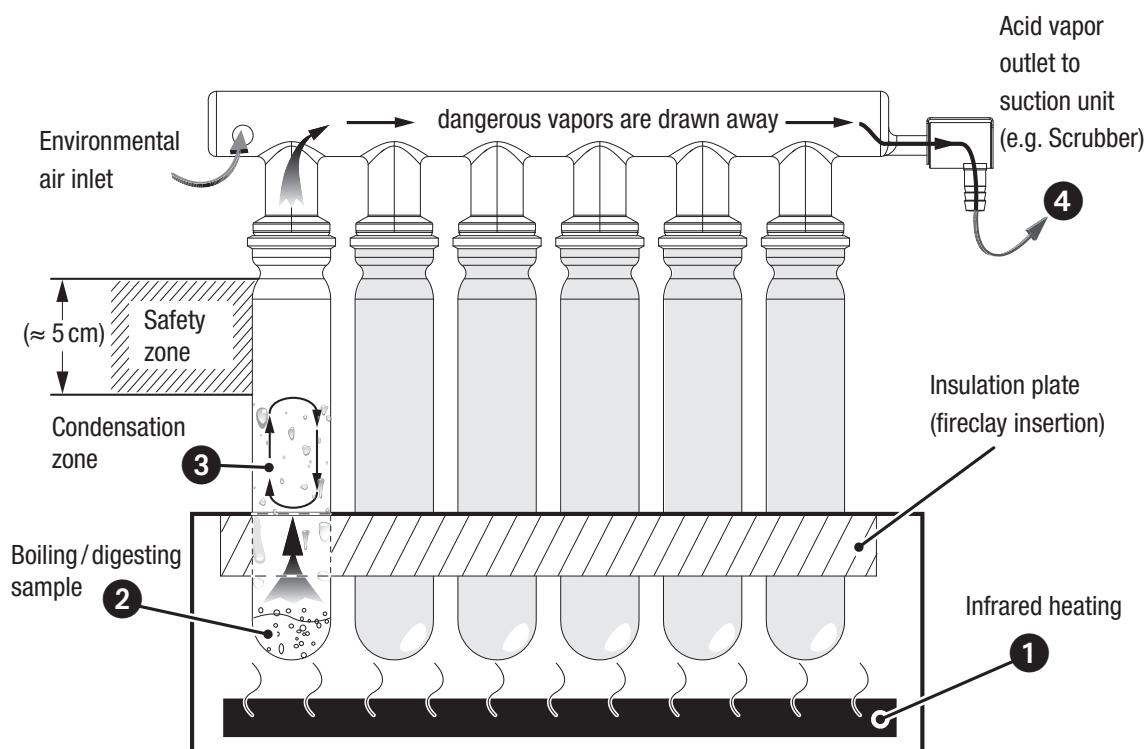

Processing steps:

- The infrared heating **1** generates high temperatures in the sample.
- Inside the sample tubes the digestion process takes place **2** while the acid is constantly boiling.
- Hot acid fumes rise into the condensing zone **3**. After reflux, the acid flows back down to the sample material, establishing a constant cycle.
- Residual fumes which escapes the condensation zone is highly corrosive (!) and hazardous to life forms. It must be withdrawn by a suction unit that delivers sufficient flow (i.e. with a Scrubber B-414 or a water jet pump) **4**.

Note

The condensation should not take place inside the safety zone in order to prevent digestion of the sealing rings. In case the condensation is too close to the suction module (e.g. due to very high temperature settings) the digestion fumes may escape and the sample can dry out!

5 Putting into operation

This chapter describes how the instrument has to be installed. It also gives instructions for the initial startup.

Note

Inspect the instrument for damage during unpacking. If necessary, prepare a status report immediately to inform your Buchi representative. In some countries it is necessary to additionally inform the postal company, railway company or transportation company. Keep the original packaging for future transportation.

5.1 Installation site



Put the instrument into a fume hood onto a clean, stable and horizontal surface. Consider the maximum product dimensions and weight. Obtain the environmental conditions as described in section 3.2, technical data.



Installation prerequisites and installation steps:

- The fume hood must be equipped with a heat- and acid-resistant lining.
- Do not place any objects on top or below the instrument.
- The instrument must be installed with a safety clearance of not less than 5 cm to any other objects or walls to allow sufficient cooling.
- Do not place containers, chemicals or other items behind the instrument.
- When using a Scrubber B-414 it must be placed on the **left** side of the SpeedDigester.

Note

- *To cut the power in case of an emergency by unplugging, the instruments or any other items must not block the mains plug!*
- *Any cooling of the SpeedDigester can disturb the digestion process. When switched 'On', the Scrubber B-414 cooling fan emits from the left side of the housing. Hence the Scrubber B-414 should not be installed on the right side of the SpeedDigester.*

 	 DANGER
	<p>Death or serious injuries by use in explosive environments.</p> <ul style="list-style-type: none"> • Do not store or operate the instrument in explosive environments • Do not store chemicals in the vicinity of the device • Operate the device in a fume hood with sufficient ventilation to directly withdraw fumes

	<p>WARNING</p> <p>Risk of death or burns by electric current.</p> <ul style="list-style-type: none"> • Check for proper grounding before use • Exchange defective cabling instantly
	<p>CAUTION</p> <p>Risk of minor or moderate injury by heavy weight of the instrument.</p> <ul style="list-style-type: none"> • Lift the instrument carefully and avoid over exertion • Do not drop the instrument or its transport box • Place the instrument on a stable, even and vibration-free surface • Keep limbs out of crushing zone

5.2 System fixation

In earthquake prone regions the instrument must be fixed to the fume hood bench. The penetration depth of the stainless steel fixation screw must not be more than 10 mm.

	<p>Notice</p> <p>Risk of instrument damage by earthquakes</p> <ul style="list-style-type: none"> • Safely attach the instrument to the bench in earthquake prone regions • Use acid resistant stainless steel screws
---	---

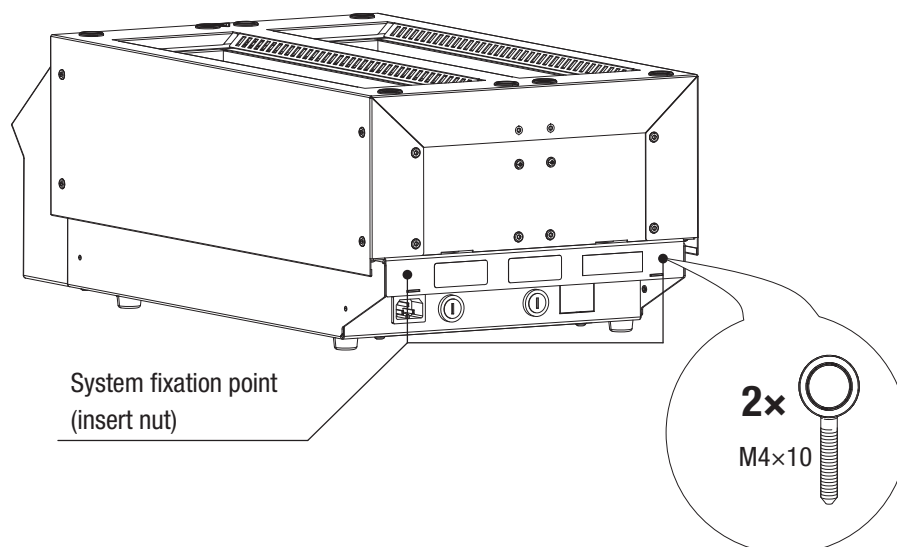

5.3 Electrical connections

5.3.1 SpeedDigester connection

After the installation procedure has been completed successfully, the power plug of the SpeedDigester must be connected to the mains for the digestion process.

	<p style="text-align: center;">Notice</p> <p>Risk of instrument damage by wrong mains supply.</p> <ul style="list-style-type: none"> • External mains supply must meet the voltage given on the type plate • Check for proper grounding
---	--

The used mains circuit has to:

- provide the voltage that is given on the type plate of the instrument.
- be able to handle the load of the connected instruments.
- be equipped with adequate fusing and electrical safety measures, in particular proper earthing.

See also technical data of all components regarding the different minimum system requirements!

Note

Additional electrical safety measures such as residual current breakers may be necessary to meet local laws and regulations! External connections and extension lines must be provided with an earthed conductor lead (3-pole couplings, cord or plug equipment). All used power cords shall be equipped with moulded plugs only to avoid risks due to unobservant defective wiring.

5.3.2 Scrubber/water jet pump connection

To start the Scrubber B-414 automatically when the digestion process starts, directly connect it to the SpeedDigester K-439 with the optional connection cable (Art. No. 14738).

Make sure that the voltage of the Scrubber B-414 corresponds to the voltage of the K-439.

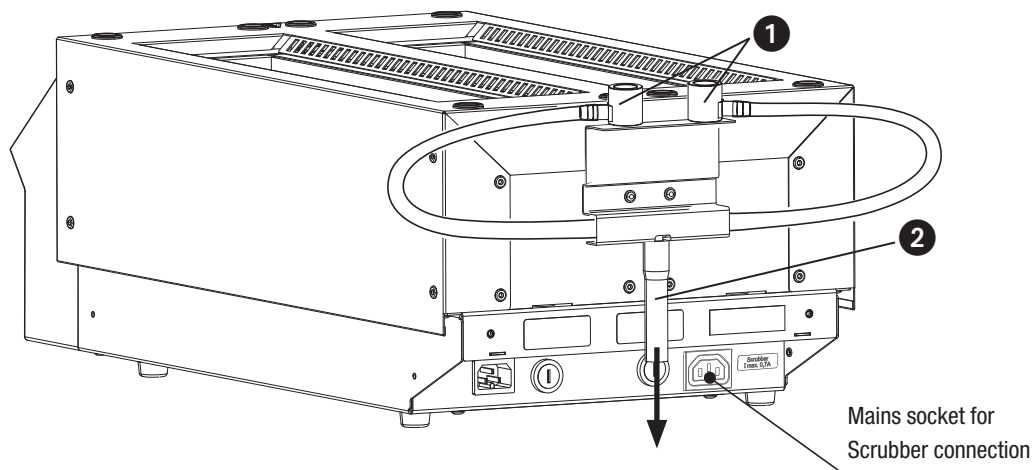

To connect a Scrubber/water jet pump the plastic adapter piece must be installed to the suction module and the hose connector must be mounted at the EPDM hose of the suction module **1** (see section 6.7.3).

Now connect the EPDM hose coming from the T-piece **2** to the Scrubber B-414 or the water jet pump to exhaust the digestion fumes (for a more detailed description see the corresponding instruction manuals of these devices). Make sure that the hose connection is as short as possible.

6 Operation

This chapter gives examples of typical instrument applications and instructions on how to operate the instrument properly and safely. See also section 2.5 “Product safety” for general warnings.

6.1 Operating controls and housing

The SpeedDigester K-439 is equipped with electronic temperature control, an integrated LC-display and a membrane keypad with multifunctional keys.

Up to 50 methods can be programmed, 20 of which are already predefined by default.

A method consists of Preheat step, 4 possible temperature steps and cooling-down time.

The programmed method is visualized graphically and during the digestion process the actual temperature and the set temperature as well as the remaining time are displayed. The current status during digestion is visualized by the icons at any time.

6.1.1 SpeedDigester K-439 – front side

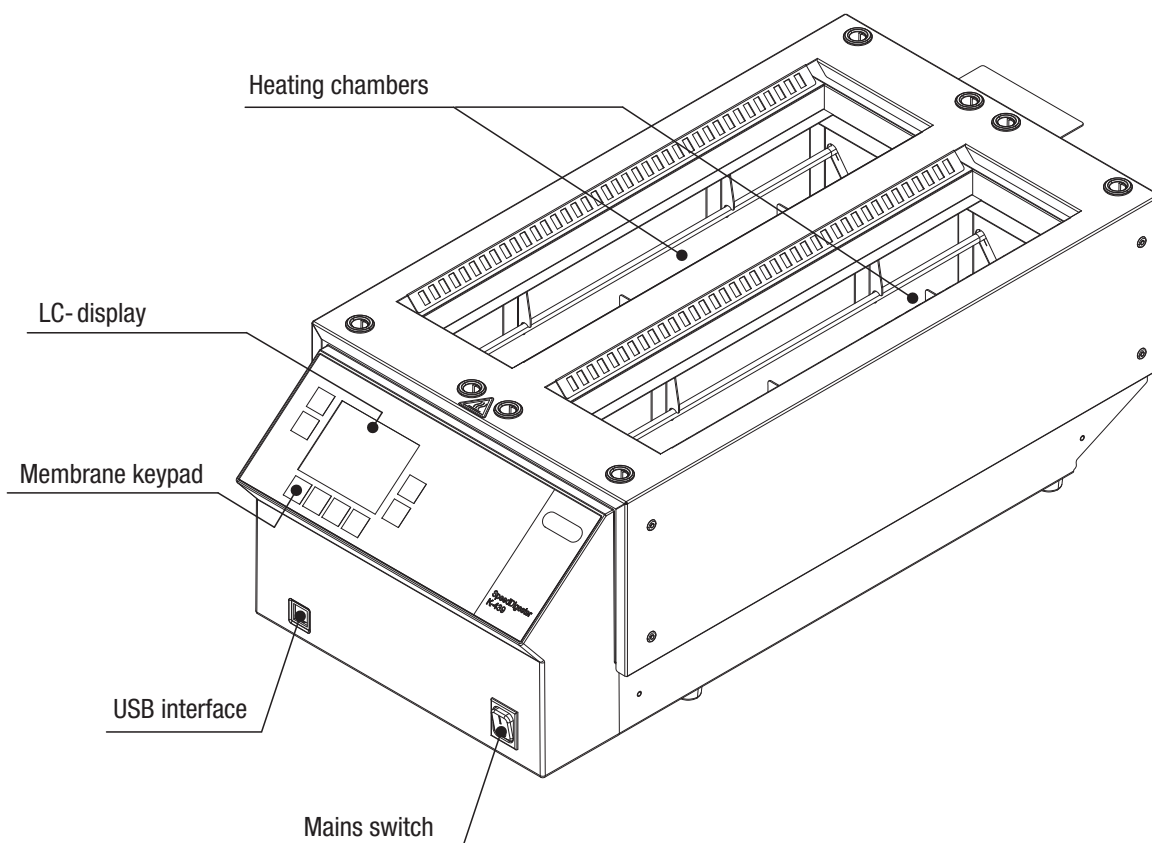

- The mains switch is illuminated green when the system is switched on
- USB interface — for service purposes only
- Membrane keypad — covered by anti-corrosion foil
- Graphical LC- display
- Two heating chambers



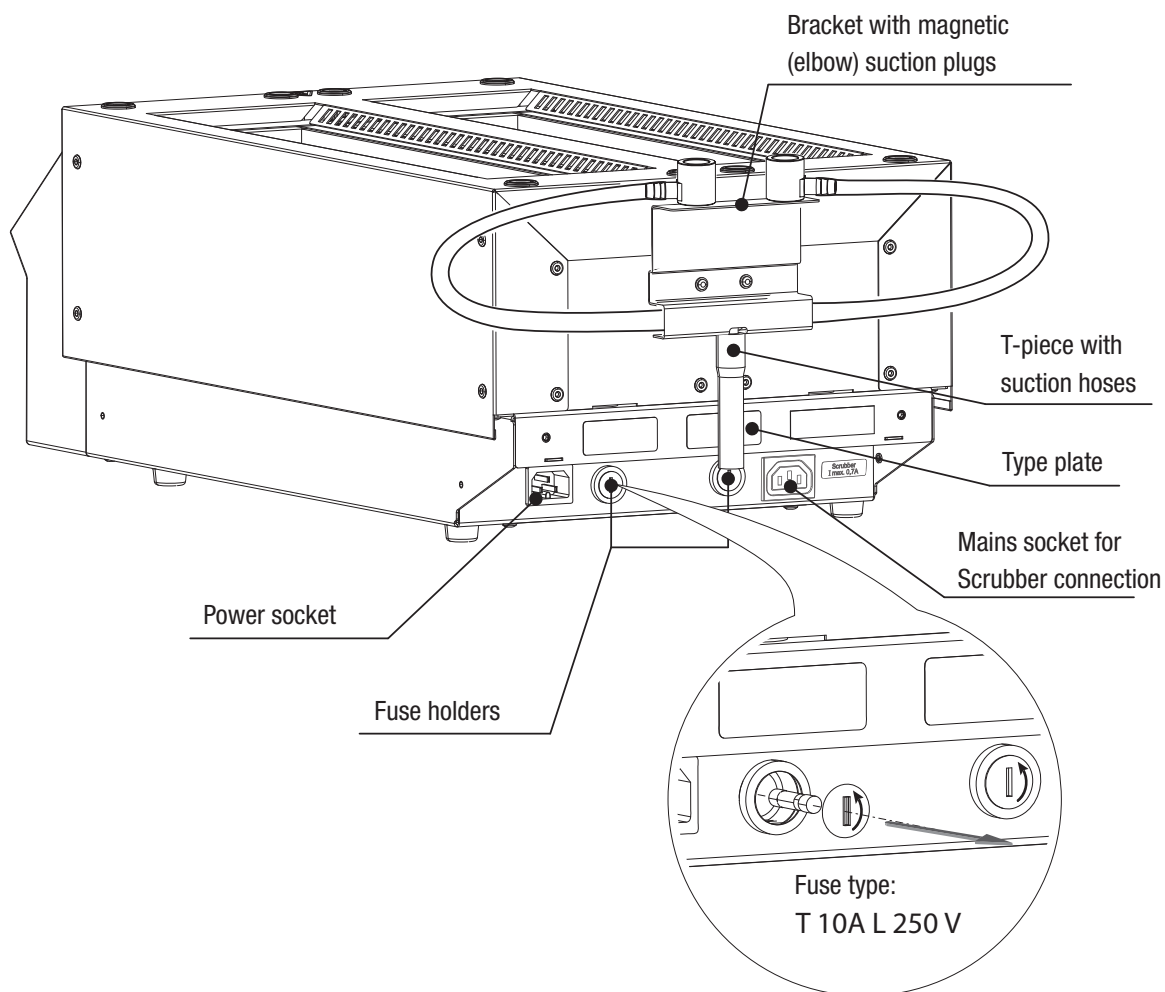

6.1.2 System rear side

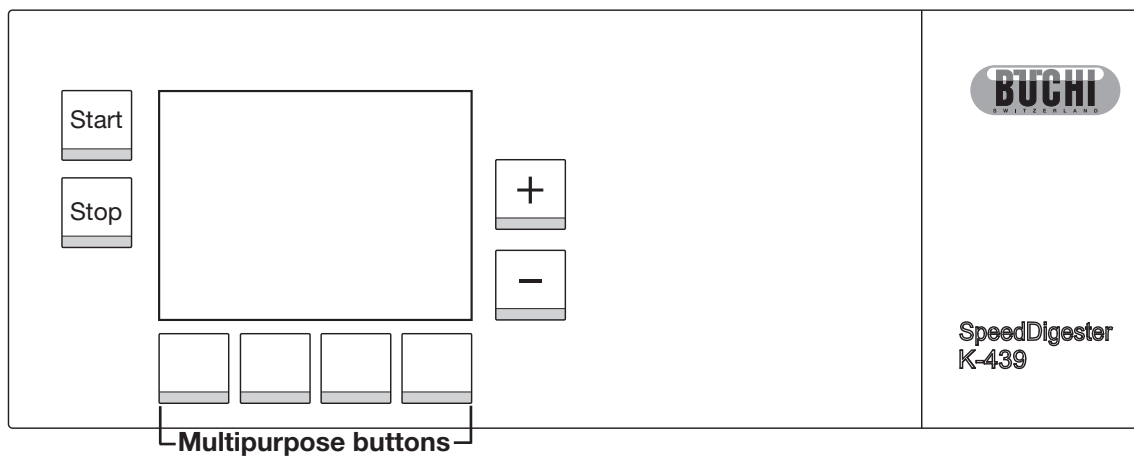

- To access the glass fuses on the rear side use a slotted screwdriver.
 - ↳ Slightly push in the slotted insert and turn it approx. a quarter-turn counterclockwise.
 - ↳ Release the pressure off the insert — it will pop out by weak spring force.

6.2 User interface



























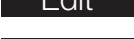

Button	Functionality
	Starts a process
	Stops a process
	<ul style="list-style-type: none"> Increases values such as time or temperature Selects adjustments
	<ul style="list-style-type: none"> Decreases values such as time or temperature Selects adjustments
	Functionality changes on the basis of the corresponding button description on the display

6.3 Program structure overview

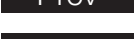
Main menu	1st submenu	2nd submenu	3rd submenu	4th submenu
Automatic	<ul style="list-style-type: none"> - choose one or both rows to be active - activate timer - activate Preheat continue/ Preheat wait Start the digestion method			
Methods	List of methods <ul style="list-style-type: none"> - user methods - Buchi methods 	Select the required method	<ul style="list-style-type: none"> - Delete Methods - Load Methods 	Configure and save a method
History	View the last 3 digestion processes			
Manual	Start a manual digestion <ul style="list-style-type: none"> - choose one or both rows to be active - start the heating - reset time 			
Settings	Language Display Contrast 15 to 85 Buzzer On/Off Scrubber present Yes/No Device Type K-439 Demo Mode: Yes/No Acceleration 1 to 60			
Diagnostics	Actors Sensors Operating hours Unit Information Service Test	Heaters temp. Scrubber On/Off Backlight On/Off Voltage, Triac, Temp. Sensor 1 and 2 Power-on Time, Heating Time, Row Left, Row Right Version Firmware, Test Date Print, Version Print, Max. Temp. Triac/LCD Start Service Test (IQ/OQ)		

6.4 Software buttons

The following control buttons are available in the software for navigation and input confirmation:

	Go on to the next screen, go to the next stored digestion process in the "History"
	Confirm and/or save a setting and get back to the main/previous screen
	Get back to the main/previous screen without saving possible settings
	Back button to move backward within in the submenu structure
	Forward button to move forward within in the submenu structure
	Back button to move backward in the lower submenu structure
	Forward button to move forward in the lower submenu structure
	Move up within the entries of a screen
	Move down within the entries of a screen
	Save a method
	Confirm the entry of a character when naming a method
	.. wait: hold temp. after preheat, start step 1 of digestion by pressing START .. continue: start step 1 of digestion automatically after preheat is done
	Select left, right or both rows to be heated
	Set required time for the delayed start time in h : min
	Extend the digestion for an additional 10 minutes
	Adjust the temperature during a running digestion in Automatic mode
	Delete a method
	Load a method
	Edit a method/settings
	Cancel the latest entry
	Go back to the previous screen/go to the previously stored digestion in the History menu
	Reset time during Manual mode
	Check rows individually (OQ Service test)
	Check both rows at once (OQ Service test)
	Start a temperature test (OQ Service test) / affirm a question
	Negate a question

6.5 Software icons

The software icons explained in the following are visible during a digestion process. Most of them are displayed in the upper part of the software screen and also remain visible when leaving the digestion screen.

Just the general icon for the selected rows and the temperature reached as well as the heating icons in the manual mode are only visible in the digestion screen.

6.5.1 General icons (used in automatic and manual mode)



The temperature of the heating chamber is ≥ 70 °C, i.e. the heating elements are hot



Scrubber is running



Selected row(s)



Data of last, last but one and last but two digestion process in History menu

6.5.2 Icons in automatic mode



Preheat function "Preheat ..wait" active. Preheating in progress.



Preheat function "Preheat ..continue" active. Preheating in progress.



Preheating finished, preheat temperature reached



Step in progress



Heating off, cool down step running

6.5.3 Icons in manual mode



Manual mode



Temperature reached, i.e. actual temperature equals set temperature



Heating, i.e. set temperature higher than actual temperature



Heating off, i.e. set temperature lower than actual temperature

6.6 How to prepare the software for routine digestion

Configure the software according to the following steps to prepare it for routine digestion:

1. Standard instrument settings
2. Manual mode (development of digestion method)
3. Digestion methods (storage of developed method)
4. Preheating
5. Start digestion

6.6.1 Standard instrument settings

This configuration consists of typical settings, which have to be defined before the instrument is used for the first time. These settings do not have to be changed, as long as the instrument is not updated or extended by any additional accessory (e.g. Scrubber B-414).

Select Main Menu > Settings.

The following screen appears:

Settings	
Display Contrast:	35
Buzzer:	On
Scrubber present:	Yes
Device Type:	K-439
Demo Mode:	No
Acceleration:	1
Edit	

The following settings can be entered:

- Language (select the required language (de, en, fr, it, es, jp, zh))
- Display Contrast (15 to 85)
- Buzzer (On or Off)
- Scrubber present (Yes, if connected / No, if not connected)
- Device Type (K-439, predefined, cannot be changed)
- Demo Mode (must be set to "No" for operation)
- Acceleration (only needed for Demo Mode)

6.6.2 Digestion in Manual Mode

The manual digestion mode is mainly used for the development of new digestion methods. The temperature is set manually and can be changed at any time. The total runtime of the digestion is displayed and can be reset.

Select Main Menu > Manual.

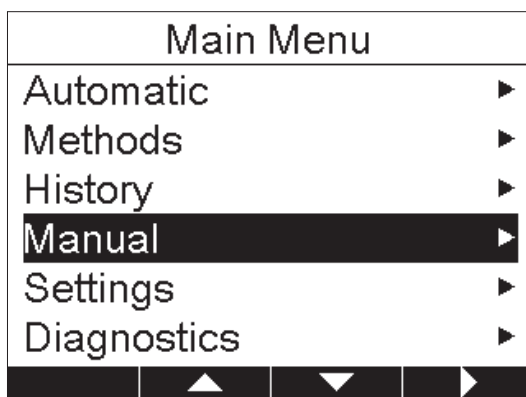

The following dialog appears:

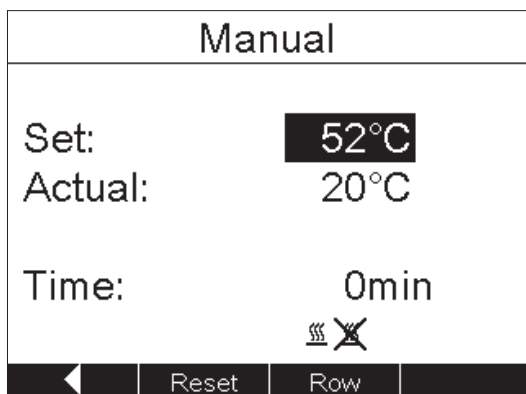

- Set the required temperature by using the \pm buttons.
- Select the row(s) to be active, by pressing Row and then the \pm buttons. Then press OK to confirm.
- Now press START. The digestion is started. Set and actual temperatures as well as the total digestion time are displayed. The digestion temperature must be adjusted manually, if required.
- Once the digestion solution has become clear, continue to boil the solution for about 30 minutes.
- Press Reset to reset the run time to zero.
- Press STOP (to stop the heating).

If a Scrubber B-414 is connected, it keeps running until the STOP button is pressed again.

6.6.3 Methods menu

The software of the SpeedDigester K-439 provides 20 predefined Buchi methods, which can be used for immediate digestion and as a basis for method development. Their names are always written in lower case letters. They cannot be deleted but modified and stored under a new name. When customer methods are available, the Buchi methods are always listed behind them.

Buchi methods

The following Buchi methods are available, e.g.:

- animal feed (for e.g. cat feed, dog feed)
- beer (for e.g. lager, wheat beer)
- beverages (for e.g. juices)
- cereal products (for e.g. flour, bran)
- chocolate (for e.g. dark and milk chocolate)
- creme (for e.g. copper lotion, face cream)
- dairy products (for e.g. milk, cheese, cream cheese)
- egg
- fertilizer (for e.g. solid and liquid fertilizers)
- function test (OQ)
- meat products (for e.g. salami, boiled sausage)
- micro kjeldahl (for e.g. milk)
- npn / ncn in milk
- nuts (for e.g. hazelnuts, almonds)
- pasta (for e.g. tortellini)
- pharma products (for e.g. tablets, drops)
- soy and tofu (for e.g. soy milk, soy sauce)
- tkn 300 (100 ml) (for e.g. water, waste water)
- tkn 500 (250 ml) (for e.g. water, waste water)
- whey powder (for e.g. WPC, whey powder)

In the following the definition of the method dairy products is listed as an example:

Preheat:	480 °C	
Step 1:	480 °C	10 min
Step 2	550 °C	10 min
Step 3	490 °C	65 min
Step 4	50 °C	0 min (not used)
Cool down		80 min

Note

For all Buchi methods a cool down time of 80 minutes is defined in case the customer cools his samples within the heating chambers. If the samples are cooled in the cooling position, a cool down time of 30 minutes is sufficient and the corresponding Buchi method can be adapted accordingly and saved under a new name.

Defining/Editing a method

It is possible to enter 30 user specific methods. For this purpose an existing Buchi method can be modified and saved under a new method name.

- Select Main Menu > Methods.

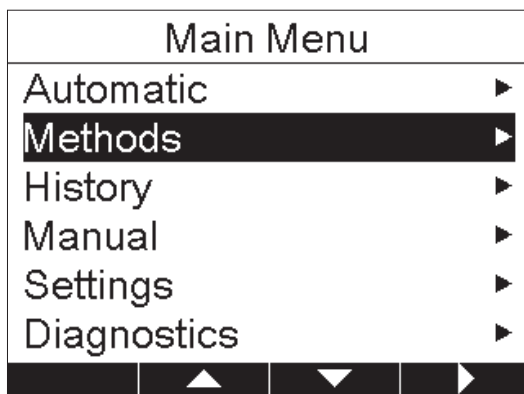

- Highlight the method that should be edited by using the up or down buttons.

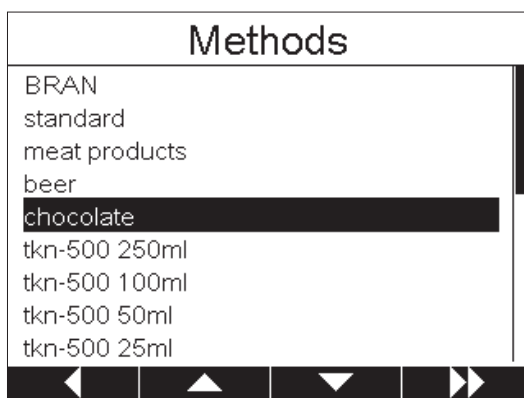

- Press >> and afterwards >.

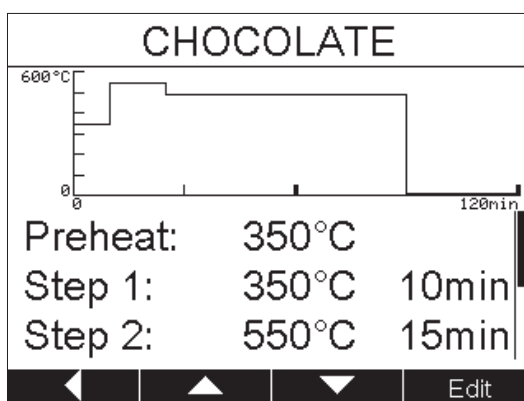

- Now press Edit.
- Select the temperature for preheating, time and temperature for the 4 possible digestion steps and the cooling down time using the ± buttons.

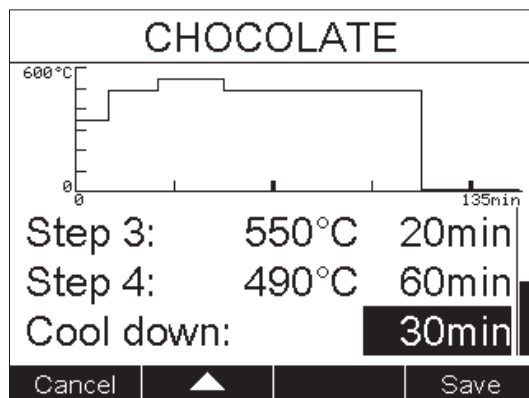
**Note**

If the rack(s) is/are cooled down inside the heating chamber, the time for the cool down step in the corresponding method must be set to ≥ 80 min, so that no harmful vapors can escape. If the racks are cooled outside the heating chamber, the cool down step in the corresponding method must be set to ≥ 30 min.

- Press Save.
- Now enter a name for the new method by highlighting individual letters on the virtual keyboard with the \pm buttons and press Enter to confirm a letter.

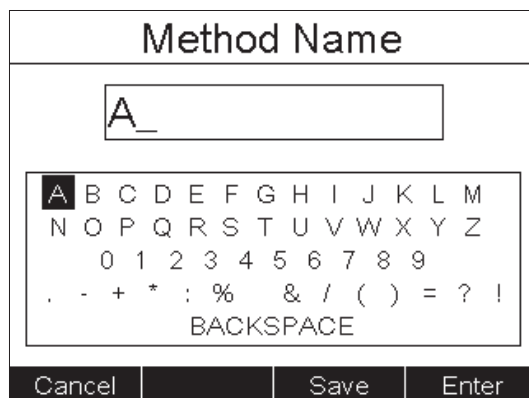

- Repeat this procedure until the name is completed.
- Press Save.

The new method now appears in the method list and can be loaded to start a digestion.

Deleting a method

The 20 Buchi standard methods predefined in the instruments software cannot be deleted. A customer specific method can be deleted as follows:

- Select Main Menu > Methods.
- Highlight the method that should be deleted by using the up or down buttons.



- Press >>.

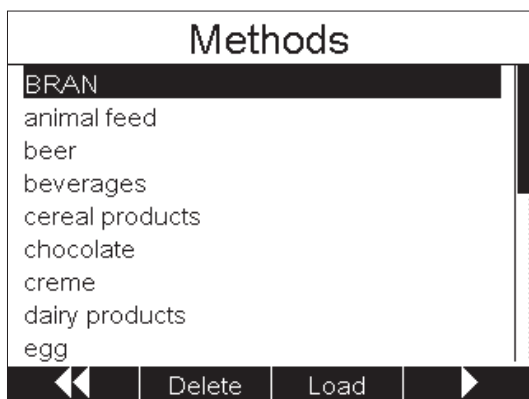

- Now press Delete. The following message appears:

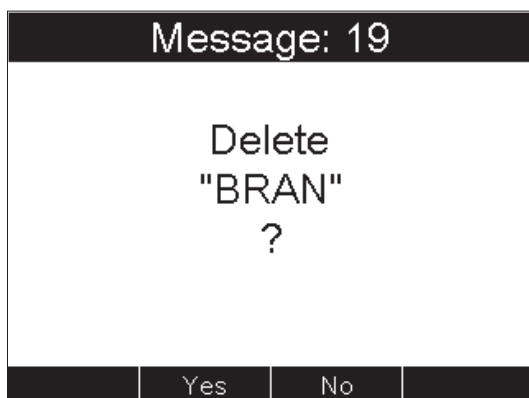

- Press Yes to confirm. The selected method is now deleted.

Starting an automatic digestion by loading a method

- Select Main Menu > Methods.
- Highlight the method that should be loaded by using the up or down buttons.

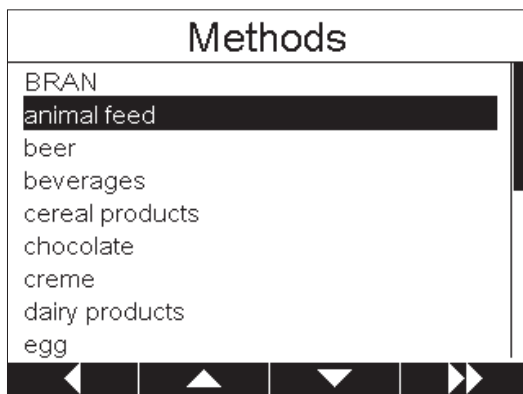

- Press >>.

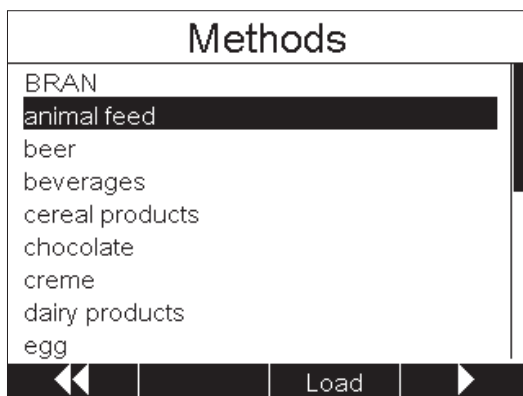

- Now press Load. The "Automatic" screen appears.

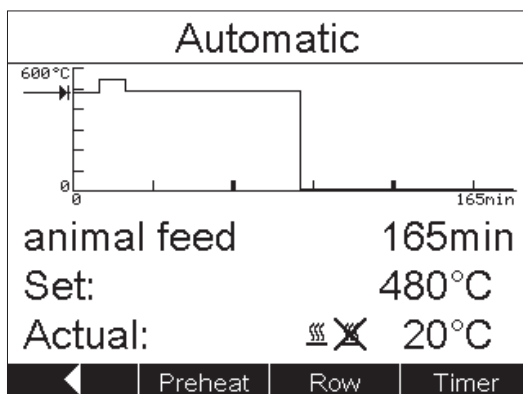

- Select the row(s) to be active, by pressing Row and then the ± buttons. Then press OK to confirm.
- To define an optional delay time for the start of the digestion, press Timer and enter the corresponding time (in hh:mm) using the ± buttons. Then press OK to confirm. The preheat function is automatically set to "Preheat ..continue" when the timer is activated.
- To change the Preheat function, press Preheat and select "..wait" or "..continue" using the ± buttons. Then press OK to confirm.
- Press the START button to start the preheating. As soon as the temperature entered for preheating is reached, the system is ready to start the digestion. The display starts blinking and the buzzer beeps three times to indicate the ready status.
- When the preheat function "Preheat ..wait" is selected, press the START button to start the digestion process.
When the preheat function "Preheat ..continue" is selected, the digestion process starts directly.

All entered steps are now run through automatically. The set and actual temperature as well as the remaining time, which includes the entered cooling-down time, are indicated on the display

- As soon as the heating process is finished, the display starts blinking, the buzzer beeps and the info message "Heating finished" appears. Confirm the message by pressing OK. The racks now have to cool down.
- When the cooling time is over the display starts blinking, the buzzer beeps and the info message "Digestion done" appears. Confirm the end of the process by pressing the OK button.

6.6.4 Digestion in Automatic Mode

A digestion in Automatic mode can be started in two different ways:

- Loading a method from the methods menu (see description above).
- Selecting the Automatic menu to start the method that was last used to carry out a digestion.

For this purpose:

- Select Main Menu > Automatic. The Automatic screen appears with the same settings as used for the last digestion process.
- You can now select the row(s) to be active, by pressing Row and then the \pm buttons. Then press OK to confirm.
- To define an optional delay time for the start of the digestion, press Timer and enter the corresponding time using the \pm buttons. Then press OK to confirm. The preheat function is automatically set to "Preheat ..continue" when the timer is activated.
- To change the Preheat function, press Preheat and select "..wait" or "..continue" using the \pm buttons. Then press OK to confirm.
- Press the START button to start the preheating. As soon as the temperature entered for preheating is reached, the system is ready to start the digestion. The display starts blinking and the buzzer beeps three times to indicate the ready status.
- When the preheat function "Preheat ..wait" is selected, press the START button to start the digestion process.

When the preheat function "Preheat ..continue" is selected, the digestion process starts directly.

All entered steps are now run through automatically. The set and actual temperature as well as the remaining time, which includes the entered cooling-down time, are indicated on the display.

The icons show, whether the heating elements are hot, the Scrubber is running, which step is currently in progress and which rows are active. The current process status is indicated on a progressive diagram.

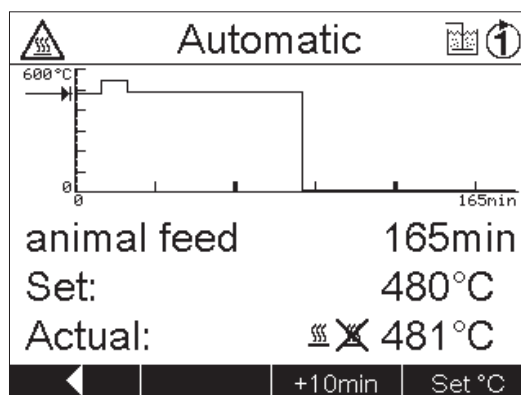

- As soon as the heating process is finished, the display starts blinking, the buzzer beeps and the info message "Heating finished" appears. Confirm the message by pressing OK. The racks now have to cool down.
- When the cooling time is over the display starts blinking, the buzzer beeps and the info message "Digestion done" appears. Confirm the end of the process by pressing the OK button.

6.6.5 History menu

The data of the last three digestions can be viewed/checked within the History menu. For this purpose select Main Menu > History. The History screen appears.

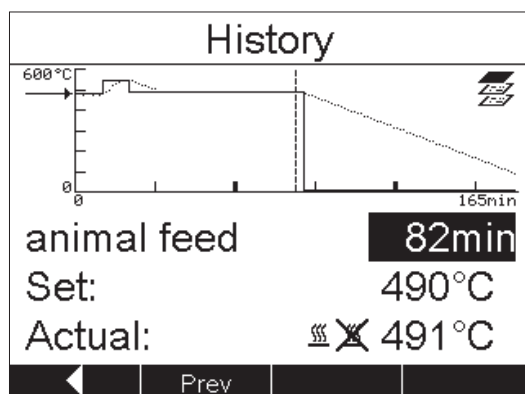





You can now navigate through the available digestion data using the Prev or Next button. To view the set and actual temperature of a certain time within the digestion process use the \pm buttons to move forward or backward on the progressive diagram.



6.7 Preparing of SpeedDigester, suction module(s) and sample tubes

Section 6.7.1 and 6.7.2 describes the standard procedure for preparing a rack with sample tubes of 300ml or 250ml. When 500ml tubes are being used, additionally refer to section 6.7.4.

Note

A rack may achieve a weight of up to 7.5 kg when loaded with samples and equipped with a suction module. Be prepared for the weight when lifting a rack!

 WARNING	
	<p>Serious chemical burns by corrosives and peroxides.</p> <ul style="list-style-type: none"> • Observe supplementary data sheets of all used chemicals • Handle corrosives and other chemicals in well ventilated environments only • Always wear protective goggles • Always wear protective gloves • Always wear protective clothes • Do not use damaged glassware • Use only glassware from qualified vendors (see 2.5.4)
	
	
	

	<p>! WARNING</p> <p>Death or serious poisoning by contact or incorporation of harmful substances at use.</p> <ul style="list-style-type: none"> • Before operation, check the instrument for correct assembling • Close unused suction module positions with glass caps • Rinse suction modules, hoses and connectors before use • Before operation inspect sealings and tubes for good condition and tightness • Exchange worn out or defective parts immediately • Only operate the instrument in a fume hood • Directly withdraw released gases and gaseous substances by a Scrubber or a water jet pump • Dispose of condensate in tubings and glassware safely after use
	<p>! CAUTION</p> <p>Risk of minor or moderate cuts when handling damaged glass parts.</p> <ul style="list-style-type: none"> • Handle glass parts with care • Do not heat up empty sample tubes in the device • Visually inspect every glass part before mounting • Exchange damaged glass parts immediately • Do not touch cracks or bits of broken glass with bare hands

6.7.1 Kjeldahl digestion – preparing sample tubes

During the preparation process, handling with strong acid and other dangerous substances is inevitable. Thus, all steps must be performed under safe laboratory conditions!

Prerequisites

- All sample tubes must be clean and free of damage.
- To achieve a reliable and reproducible digestion result the quality of sample material and additives (e.g. acid and catalyst) must be free of impurities and of adequate amount.

Filling of a sample tube

- Take the sample tubes sequentially and weigh in sample material.
Add catalyst to the samples (e.g. Kjeldahl tablets, order no. 028765).
- Carefully(!) add sulfuric acid ($\approx 98\%$) of sufficient amount for the samples.

➔ The sample tubes can now be installed in the rack.

Note

- *Note down the sample weight and position to keep the probe processing and its analysis reproducible. All racks are marked on top with a "1" for the first sample position.*
- *The rack(s) can be used as a temporary storage for empty tubes during the preparation process.*
- When adding the sulfuric acid, rotate the tube to wash down any sticky sample material to the bottom and to coat the inside of the tube.

6.7.2 Peroxide digestion — preparing sample tubes

During the preparation process, handling with peroxides and other dangerous substances is inevitable. Peroxides are strong oxidants and can form explosives! All steps must be performed under safe laboratory conditions.

	<p>! WARNING</p> <p>Death or serious injuries by toxic and explosive peroxides.</p> <ul style="list-style-type: none"> • Use only damage free sample tubes • Exchange worn out or defective parts immediately • Handle peroxides in a fume hood • Do not bring peroxides into contact with highly combustible material
---	---

Prerequisites

- All sample tubes must be clean and free of damage.
- To achieve a reliable and reproducible digestion result the quality of sample material and the peroxide must be free of impurities and of adequate amount.

Filling of a sample tube

- Take the sample tubes sequentially and weigh in sample material.
- Carefully(!) add diluted sulfuric acid (e.g. 69%) of sufficient amount to the samples.
- Carefully(!) add peroxide (e.g. H₂O₂ 30%) of sufficient amount to the samples.

➔ The sample tubes can now be installed in a rack.

Note

- *Note down the sample weight and position to keep the probe processing and its analysis reproducible. All racks are marked on top with a "1" for the first sample position.*
- *The rack(s) can be used as a temporary storage for empty tubes during the preparation process.*
- When adding the sulfuric acid and peroxide, rotate the tube to wash down any sticky sample material to the bottom and to coat the inside of the tube.

6.7.3 Installing a suction module and sample tubes (300 ml)

To withdraw hazardous fumes and vapors a suction module must be installed.

Prerequisites:

All hoses and connectors must be unclogged.

Installation steps:

For installation and handling all parts must be < 40 °C!

- Install the plastic adapter piece to the suction module ❶.
- Mount the hose connector at the EPDM hose ❷ of the suction module (i.e. Scrubber B-414 or water jet pump).
- The connector at the EPDM hose can be stored temporarily at the magnetic bracket at the rear side of the SpeedDigester.

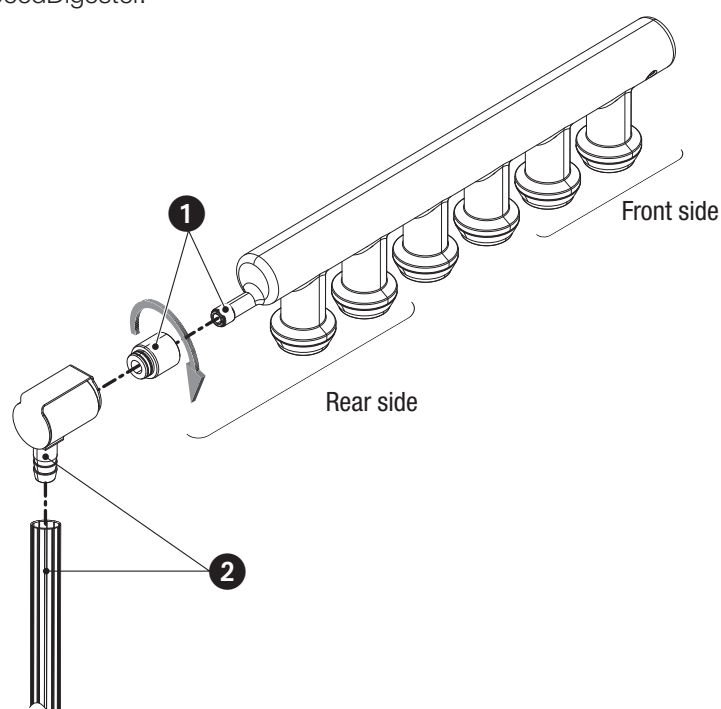

- Insert the prepared sample tubes into the rack(s) — start with the first (front) position.
- When the digestion session does not require a full set of samples, then fit unused positions with a glass cap to seal the suction circuit!

Note

- Make sure the adapter piece is tightened well without damaging the glassware.
- Keep suction hose(s) as short as possible under the given circumstances.
- Unused positions should be arranged at the rear end of the rack.

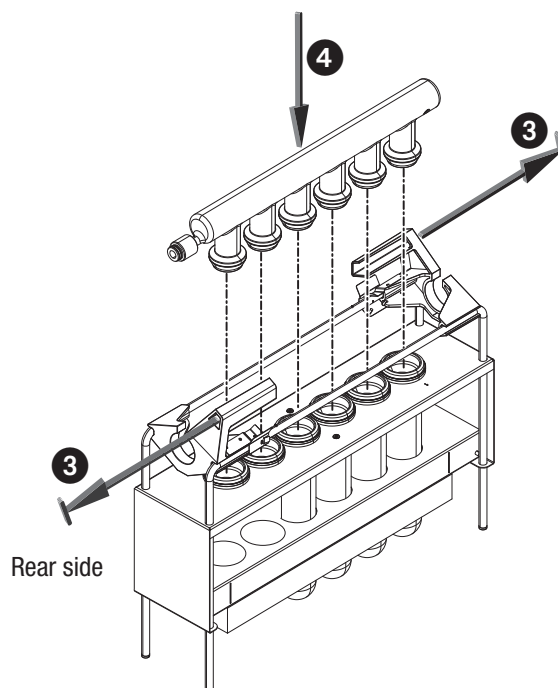

- Lift the metal clips to unlock and shift the black handles 3 aside.
- Carefully push down the suction module 4 straight onto the sample tubes and shift the handles back into locking position.
 - ↳ The metal clips must snap in to securely lock the handles position!

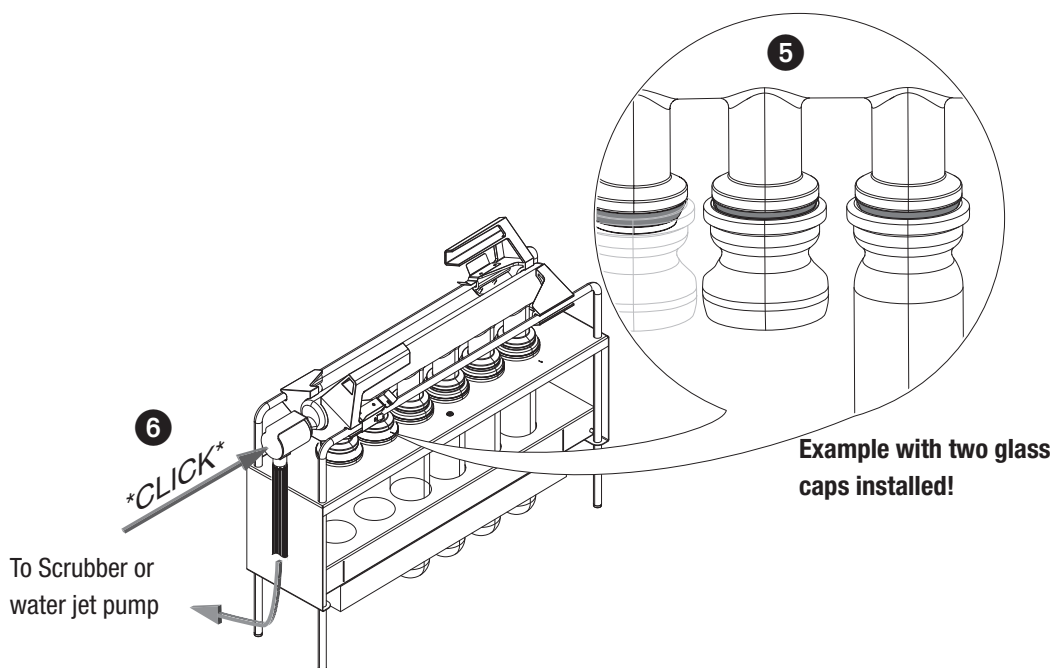

- Check for proper and tight seating of each rubber sealing 5.
 - ↳ If necessary unlock the handles again and readjust the suction module!
- Plug the suction hose with plug onto the suction module 6.
 - ↳ The plug catches with a noticeable *click* sound.

- If applicable, follow the previous steps to install a suction module on a second rack.
- Switch on the Scrubber or water jet pump and activate the fume hood ventilation.

➔The rack(s) can now safely be processed in the SpeedDigerster.

Note

- Clean all glass parts before mounting to avoid cross contamination.
- When a water jet pump is used, hazardous vapours can escape into the environmental air if the suction is inadequate.
- If a Scrubber without condensation step is used, the condensate that accrues must be absorbed by means of a Woulff bottle between the SpeedDigerster K-439 and the Scrubber.
- When operating with 3rd party sample tubes no insulation caps and glass caps are available. In this case, all positions must be equipped with samples!
- When operating with 300 ml sample tubes, close unused positions with a glass cap towards the suction unit.

6.7.4 Installing 500 ml sample tubes

Unlike 300 ml (and 250 ml) sample tubes, 500 ml tubes can not simply be inserted into the appropriate rack. The information in this section serves to set up this type of sample tube properly and safely in the rack.

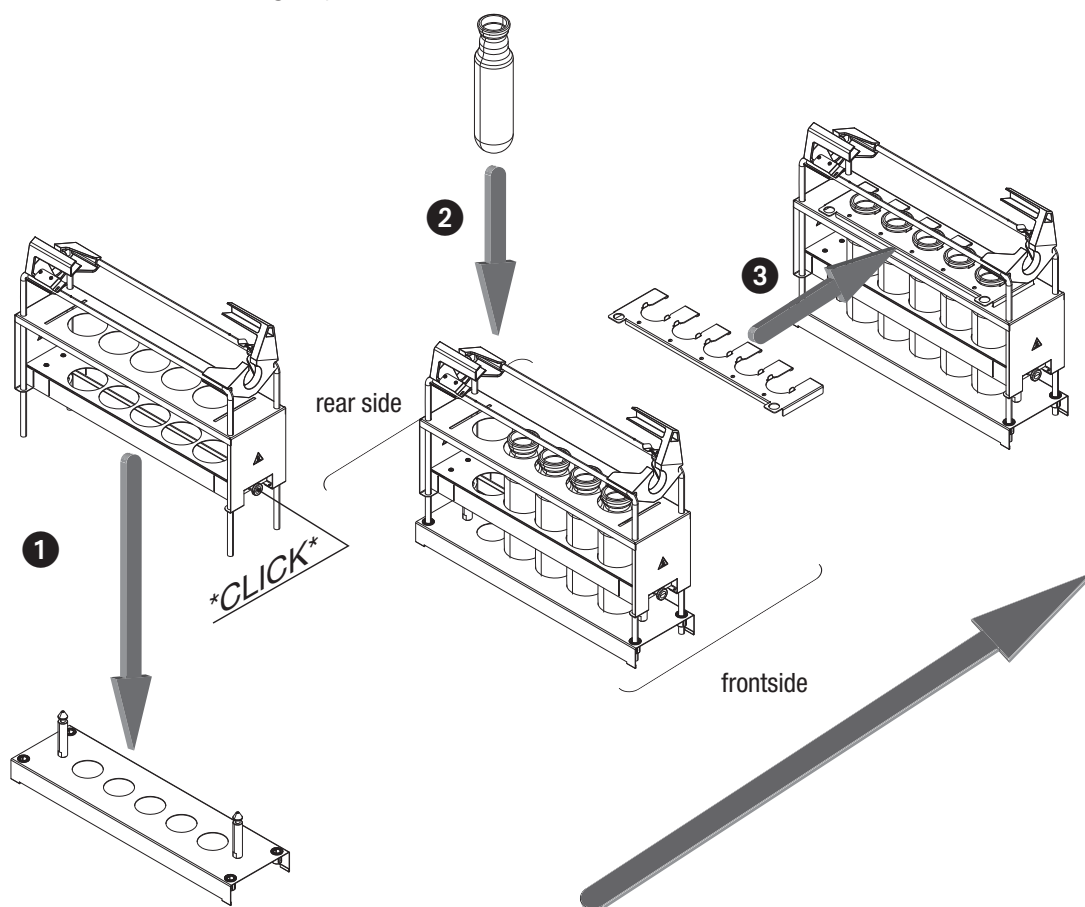

Installation steps:

For installation and handling all parts must be < 40 °C!



- Plug the rack into the carrier ①.
 - ↳ Two audible *click* sounds will appear as soon as the rack is securely locked at the carrier!
 - ↳ Check the locking by lifting the rack together with the carrier (carrier must follow the rack)

- Insert the prepared sample tubes into the rack(s) ②— start with the first (front) position.
- Install the rake ③ to interlock the sample tubes at their head side. Check for secure interlocking!
- To separate the rack from the carrier, pull the unlock buttons ④ on both sides of the rack and lift it off the carrier.

⚠ WARNING	
 	<p>Risk of death or serious chemical burns by acids or peroxides when rack tilts.</p> <ul style="list-style-type: none"> • Do not use faulty parts • Install the rack on an even and stable surface • Support the rack at the handlebars when installing the rake • Check for proper seating and safe position of the glassware before lifting the rack from the carrier

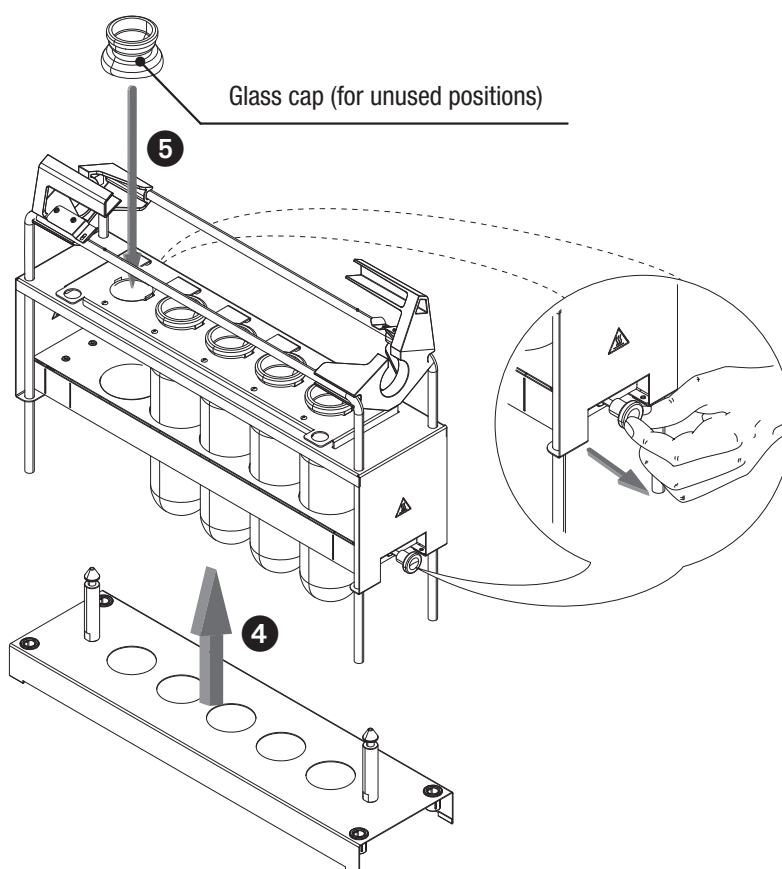

- When the digestion session does not require a full set of samples equip unused positions with a glass cap to tighten the suction circuit ⑤!
 - Follow the installation steps in section 6.7.3 to install the suction module.
 - If applicable, follow the previous steps to install sample tubes in a second rack.
- ➔ The sample tubes are now securely installed in the rack(s) and can now safely be processed in the SpeedDigester.

Note

- *Unused positions should be arranged at the rear end of the rack.*
- *Close unused positions with a glass cap towards the suction unit.*

6.7.5 Starting up the SpeedDigester

System preconditions

The system must be correctly installed and fully functional. All parts must be in proper condition (e.g. clean and free of damage). See also section 2.5 "Product safety" for general warnings!

Start-up procedure

- Select and install insulation plate(s) according to the type of sample tubes.
- Install insulation caps at unused positions of the insulation plate(s) for 300 / 500 ml racks.
- Make sure the SpeedDigester K-439 is properly connected to the mains supply.
- Make sure the Scrubber B-414 is properly connected to the K-439 or to the mains supply.
- Start the ventilation of the fume hood.
- Switch on the SpeedDigester K-439 at the mains switch at the front.
- The digestion can now be started in the Automatic or in the Manual Mode of the system.

Note

For operation with 3rd party sample tubes no insulation plates and glass caps are available. Hence, all positions must be equipped with samples!

6.8 Performing a Kjeldahl digestion process

This section is divided into two consecutive sub-sections (6.8.1 and 6.8.2) and follow-up actions in section 6.10. Do not skip or mix up these steps to ensure safe handling and best performance.

Note

Application notes are available for various samples at Buchi. These notes work as digestion recipes and give detailed instructions how to process specific sample materials. For application notes, contact your Buchi application specialist or your local distributor.

The 20 predefined Buchi standard methods help to operate the instrument "plug and play" and as a basis to develop your own methods.

6.8.1 Preparational steps

1. Start-up the SpeedDigester.
2. Let the system heat up (Preheat function in Automatic mode)
3. Prepare the sample tubes according to the type of digestion under safe conditions.

➔ The samples are now ready to be digested.

6.8.2 Starting a digestion process

4. Install the rack(s) according to the chosen sample tube size.
 - ↳ Place glass caps (order no. 040049) into every unused position of the rack
 - ↳ Place insulation caps (order no. 11056024) into every unused position at the insulation plate
 - ↳ To securely withdraw harmful fumes, switch on the suction unit (Scrubber or water jet pump) before inserting the racks into the instrument!
5. The digestion process starts, as soon as the sample tubes heat up in the instrument.
 - ↳ The Scrubber must be switched on.
 - ↳ If the Scrubber is directly connected to the K-439, it will start as soon as "Step 1" of the selected method starts and stops after the cooling-down time defined within the method is finished.

- ↳ Depending on the sample material and acid/catalyst composition it might be necessary to vary the digestion temperature at different time intervals (digestion method).
6. At the end of an Automatic digestion confirm the corresponding info message "Digestion done" by pressing OK. At the end of a Manual digestion press Stop to finish the process, then switch off the instrument via the mains switch.
- ➔ The samples are now digested. Follow-up actions are described in section 6.10.

6.9 Performing a peroxide digestion process

This section is divided into two consecutive sub-sections (6.9.1 and 6.9.2) and follow-up actions in section 6.10. Do not skip or mix up these steps to ensure safe handling and best performance.

Note

Application notes are available for various samples at Buchi. These notes work as digestion recipes and give detailed instructions how to process specific sample materials. For application notes, contact your Buchi application specialist or your local distributor.

The 20 predefined Buchi standard methods help to operate the instrument "plug and play" and as a basis to develop your own methods.

6.9.1 Preparational steps







1. Start-up the SpeedDigester.
2. Let the system heat up (Preheat function in Automatic mode)
3. Prepare the sample tubes according to the type of digestion under safe conditions.

➔ The samples are now ready to be digested.

6.9.2 Starting a digestion process

4. Install the rack(s) according to section 6.7.3. For peroxide digestion a 'Suction module H₂O₂' with funnels must be installed!
 - ↳ Place glass caps (order no. 040049) into every unused position of the rack
 - ↳ Place insulation caps (order no. 11056024) into every unused position at the insulation plate
 - ↳ To securely withdraw harmful fumes, switch on the suction unit (Scrubber or water jet pump) before inserting the racks into the instrument!
5. The digestion process starts, as soon as the sample tubes heat up in the instrument.
 - ↳ The Scrubber must be switched on.
 - ↳ If the Scrubber is directly connected to the K-439, it will start as soon as "Step 1" of the selected method starts and stops after the cooling-down time defined within the method is finished.
 - ↳ Depending on the sample material and acid/peroxide composition it might be necessary to vary the digestion temperature at different time intervals (digestion method).
 - ↳ During the digestion process it is necessary to add peroxide. Carefully and slowly(!) add peroxide into every sample probe via the funnel of the suction module (see following illustration).
6. At the end of an Automatic digestion confirm the corresponding info message "Digestion done" by pressing OK. At the end of a Manual digestion press Stop to finish the process, then switch off the instrument via the mains switch.

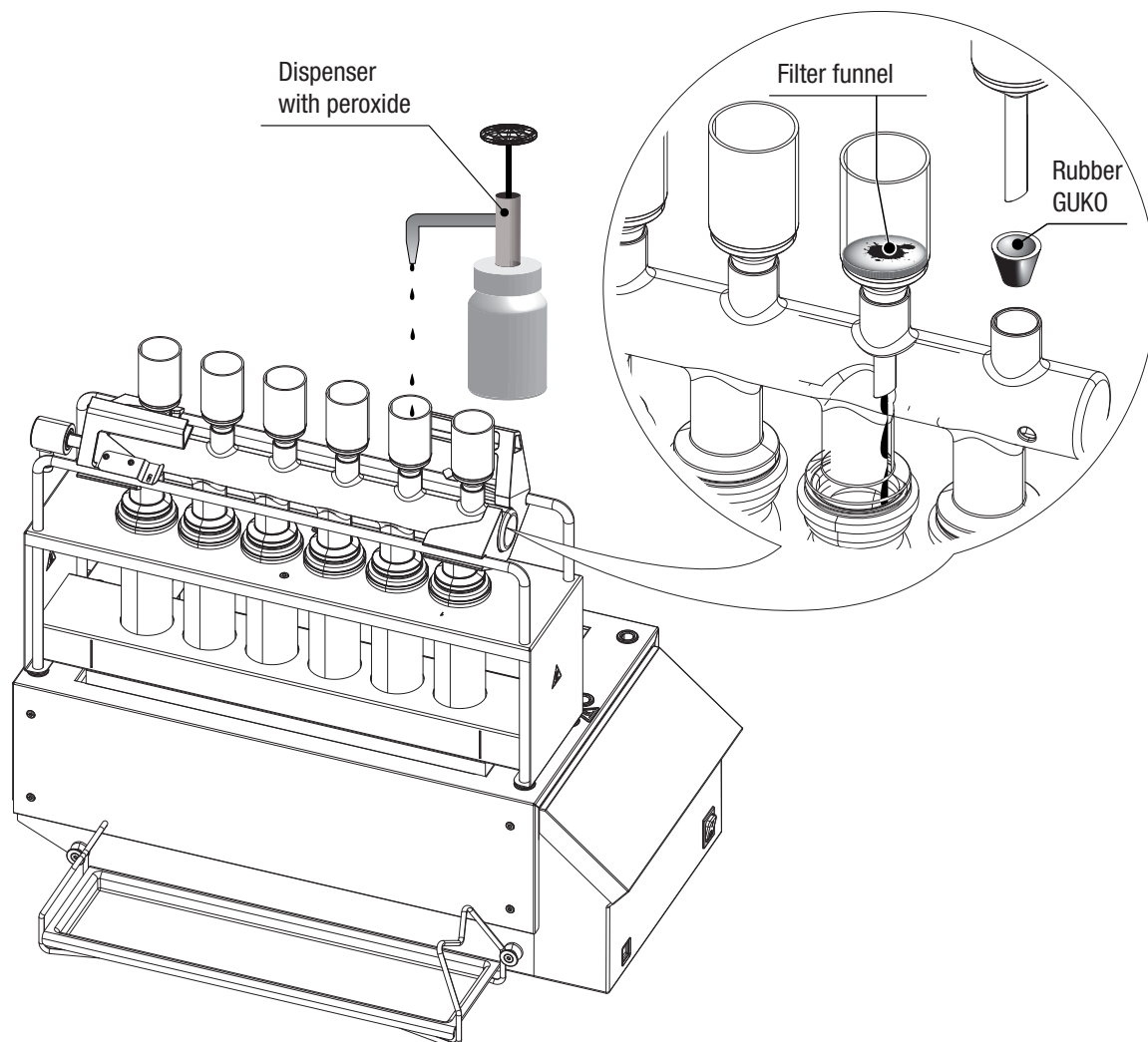

➔ The samples are now digested. Follow-up actions are described in section 6.10.

 DANGER	
    	<p>Risk of death or serious injuries by toxic and explosive peroxides.</p> <ul style="list-style-type: none"> • Use only original glassware and funnels • Do not use damaged filter funnels • Only add peroxides directly into the hot sample via filter funnel • Exchange worn out or defective parts before digestion • Handle peroxides in a fume hood • Do not bring peroxides into contact with highly combustible material



The funnels are placed decentralized (shifted out of the middle) above the sample tubes to prevent peroxide dripping directly into the hot sample. The filter funnel ensures that the peroxide can not flush into the hot sample to avoid dangerous deflagration of the peroxide and the sample.





6.10 Finishing a digestion process

 	 WARNING
	<p>Risk of dangerous or moderate burns when handling hot parts and sample tubes.</p> <ul style="list-style-type: none"> • Do not touch any hot parts • Let the system cool down • Cover unused positions with insulation cap(s) at the insulation plate(s)

After the digestion process has been completed, the sample tubes must cool down!

Metal surfaces of the rack and the SpeedDigester might be hot!

- ↳ When the Scrubber is directly connected to the SpeedDigester it is still running until the cooling-down time is completed. Then it stops automatically.
- ↳ Let the rack cool down inside the heating chamber (can take more than 60 minutes!) or (for racks with 300 ml/250 ml tubes only) use the black handles at the rack to put one or more racks into the cooling position of the SpeedDigester (see illustration below) as soon as the info message "Heating finished" appears. Confirm the message by pressing OK.
 - If the Scrubber is not connected, let the rack(s) cool down below 40 °C first, then switch off the Scrubber or water jet pump.
 - When the info message "Digestion done" appears, confirm it with OK. The suction module(s) can now be removed. Be careful to avoid acid drops.
 - ↳ The suction modules should be safely stored e.g. on a "Stand with drip tray" (order no. 11055216) to safely collect remaining acid condensate. or
 - ↳ Unplug the suction hose connector(s) from the suction module, place them on the magnetic bracket and lift off the complete rack(s) including the suction module(s).
 - To take the sample tubes off its rack, proceed with section 6.7.3 and 6.7.4 (for 500 ml sample tubes only) in reverse order.

   	 Caution
	<p>Risk of moderate chemical burns by splashing acid or peroxide drops.</p>
	<ul style="list-style-type: none"> • Carefully unplug the suction hose connectors • Wipe off any liquid drops from the suction hose connectors • Carefully store the magnetic suction hose connectors on top of the bracket at the device rear side • Avoid fast snapping of the magnetic catch • Wear safety goggles • Wear safety gloves

- ➔ The digestion output can now be processed (e.g. by a Kjeldahl distillation system).

Cooling positions of SpeedDigester K-439

The side position shown in the drawing below is only applicable for 300 ml and 250 ml sample tubes and racks. Due to the larger diameter of 500 ml sample tubes the glassware does not fit between rack and housing. Racks with 500 ml sample tubes must not be installed in this position (see illustration)!

300/250 ml rack in side position
(DO NOT USE THIS POSITION FOR 500 ml RACKS / TUBES)

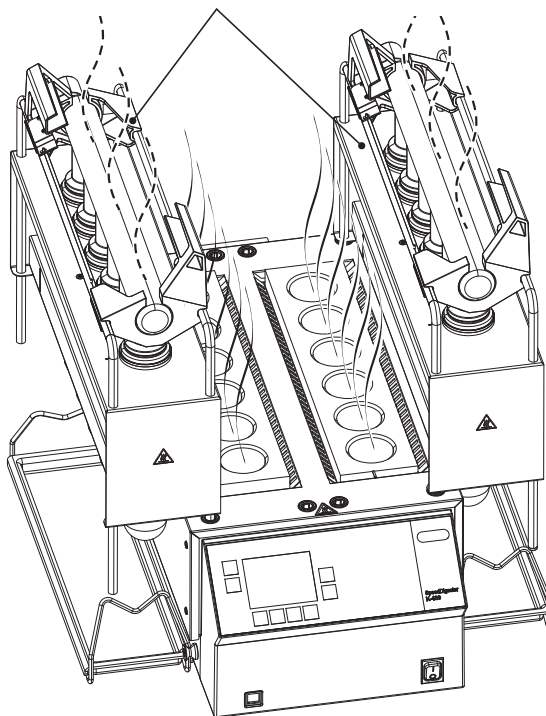



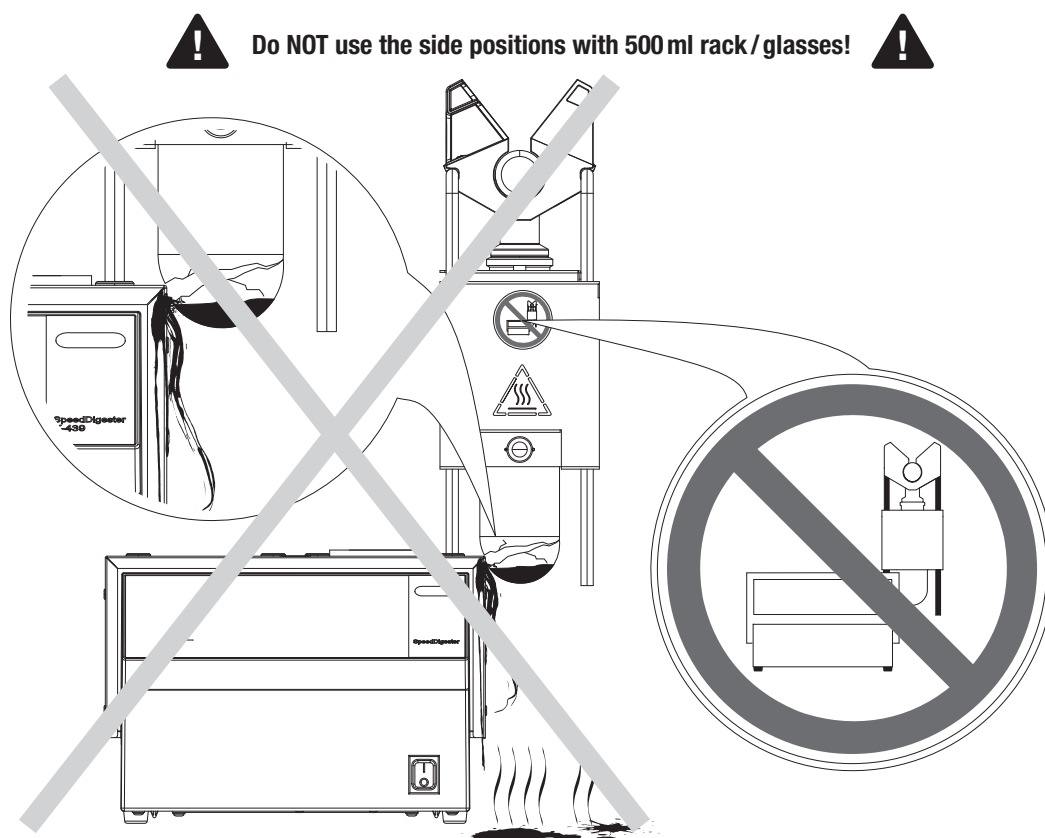

Note

- *A color change takes place during the cooling. At this time, the sample is still too hot to proceed!*
- *Digested samples which are left undistilled over a long period tend to solidify.*
If this happens:
 - ↳ *Carefully add a small quantity of distilled water*
 - ↳ *Alternatively: Slightly warm up the sample in the SpeedDigester again*



500ml racks must be placed beside the SpeedDiger K-439 to avoid a crash between the sample tubes and the housing. Nonobservance will lead to hazardous situations especially when the sample tubes are filled and hot!

! WARNING	
   	<p>Death or serious injuries at glass breakage by hot acid and catalyst or peroxide.</p> <ul style="list-style-type: none"> • Do not place racks with 500 ml sample tubes into side position • Place racks onto a stable horizontal surface inside a fume hood for cooling

6.11 Optional 'Stand with drip tray'

The optional accessory drip tray serves to collect condensated acid which might drip off the suction module(s) after a digestion process and as a space saving way to securely store a suction module.

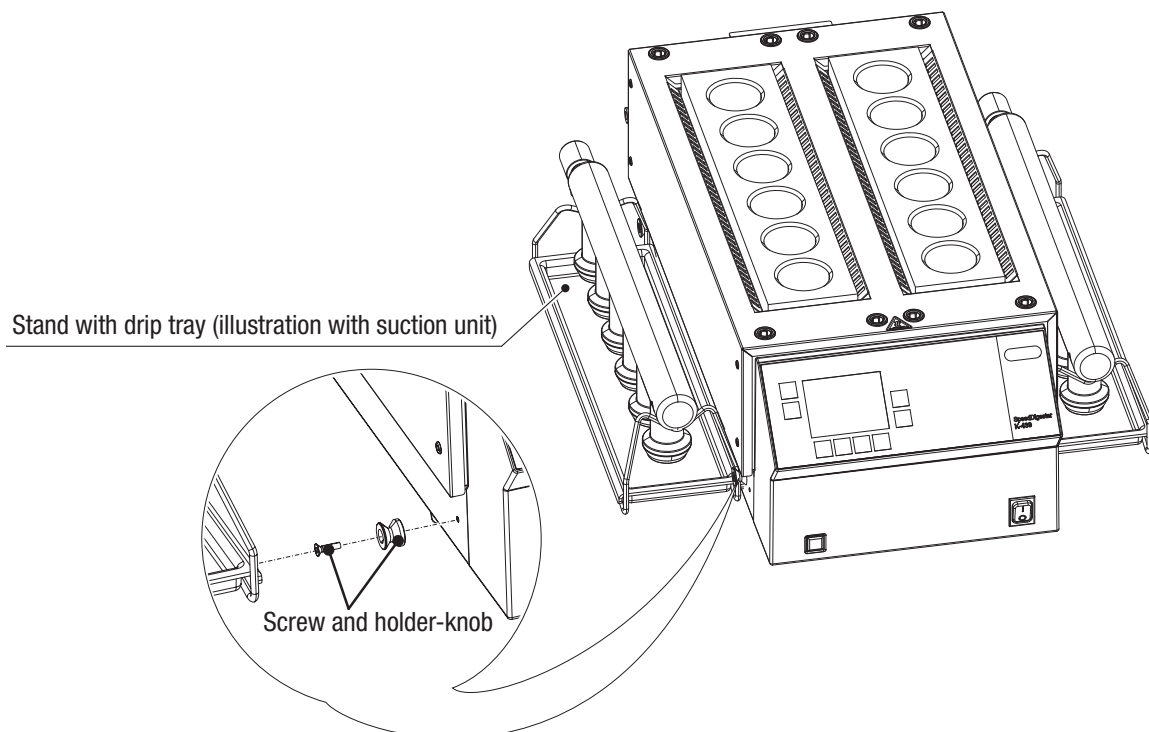

Installing a drip tray

1. Screw the two holder-knobs into the designated threads at the side of your SpeedDigester.
2. Hook-in the frame of the drip tray.



➔ The tray is now ready to use.

7 Maintenance and repairs

This chapter gives instructions on maintenance work to be performed in order to keep the instrument in a good and safe working condition. All maintenance and repair work requiring the opening or removal of the instrument housing must be carried out by trained service personnel and only with the tools provided for this purpose.

Note

Use only genuine consumables and spare parts for any maintenance and repair work in order to assure warranty and continued system performance. Any modifications of the SpeedDigester K-439 or parts of it need prior written permission of the manufacturer.

	<p>! WARNING</p> <p>Serious chemical burns by corrosives.</p> <ul style="list-style-type: none"> • Observe supplementary data sheets of all used chemicals • Handle corrosives in well ventilated environments only • Always wear protective goggles • Always wear protective gloves • Always wear protective clothes • Do not use damaged glassware
	<p>! WARNING</p> <p>Death or serious burns by electric current.</p> <ul style="list-style-type: none"> • Switch off the instrument, disconnect the power cord and prevent unintentional restart before touching the heating elements • Do not spill liquids over the device
	<p>! CAUTION</p> <p>Risk of minor or moderate cuts when handling damaged glass parts.</p> <ul style="list-style-type: none"> • Handle glass parts with care • Visually inspect every glass part for good condition before mounting • Exchange damaged glass parts immediately • Do not touch cracks or bits of broken glass with bare hands

	NOTICE
	<p>Risk of housing and instrument damage by liquids and detergents.</p> <ul style="list-style-type: none"> • Do not spill liquids over the instrument or parts of it • Wipe off any liquids instantly • Use ethanol or soapy water as detergent only

7.1 Customer service

Only authorized service personnel are allowed to perform repair work on the instrument. Authorization requires a comprehensive technical training and knowledge of possible dangers which might arise when working at the instrument. Such training and knowledge can only be provided by Buchi.

Addresses of official Buchi customer service offices are given on the Buchi website under: www.buchi.com. If malfunctions occur on your instrument or you have technical questions or application problems, contact one of these offices.

The customer service offers the following:



- Spare part delivery
- Repairs
- Technical advice

7.2 General condition and cleaning instructions

Check the housing for visible defects (switches, plugs, enclosure etc.) and clean it regularly under safe conditions with a damp cloth.

Cleaning under safe conditions

- Switch off the SpeedDigester and unplug the power cord
- ➔ Let the system cool down completely!
- Check all sealings and tubes for good condition (e.g. signs of mechanical stress and or brittleness) and proper sealing. Exchange defective parts!
- Clean all sealings with distilled water.
- Disconnect all tubings/connectors and rinse them thoroughly with water.

 	WARNING
	<p>Death or serious burns by electric current at cleaning.</p> <ul style="list-style-type: none"> • Switch off the instrument • Disconnect the power cord and prevent unintentional restart • Wait until the instrument is completely dry before reconnecting to mains

All parts must be completely dried before the system can be connected to mains again!

7.2.1 Breakage of glassware inside a housing chamber

Under rare conditions charged sample tubes or other glassware might break inside a housing chamber. In such a case strictly follow the cleaning instructions below!

Cleaning under safe conditions



- Switch off the SpeedDigester and unplug the power cord.
- Let the system and the rack(s) cool down completely!
- Carefully remove the installed rack(s).
- Wear safety gloves to dispose of the defective glassware of the rack.
- Use a long forceps to remove residual bits of glass off the housing chamber(s).
- Use a long forceps to dab residual liquid and other components off the chamber(s).
- Wear cut- and acid-safe gloves to wipe out the chamber(s) with wet damp cloth
- Check the surface below the instrument and clean if necessary

Wait for the system to completely dry before reconnecting the device to mains!

7.2.2 Liquid ingress into the instrument

In case of liquid ingress into the housing the instrument is not safe to use anymore. Follow the instructions below to safely bring the instrument into operable condition again.

- Switch off the SpeedDigester and unplug the power cord.
- Use a long forceps to dab liquid off the outer housing parts. Wear safety gloves!
- Carefully remove rack(s) if installed.
- ➔ Let the system cool down completely!
- Use a long forceps to dab residual liquid off the chamber(s).
- Wear cut- and acid-safe gloves to wipe out the chamber(s) with dry cloth.
- Use a long forceps to clean the chamber(s) with a wet damp cloth.
- ➔ Call service! Do not reconnect the system to mains

 	! WARNING
	<p>Death or serious burns by electric current.</p> <ul style="list-style-type: none"> • Switch off the instrument • Disconnect the power cord and prevent unintentional restart

All parts must be completely dried before the system can be checked by a service technician!
An electrical safety test and a functional test must be performed before the system can be used again.

7.3 Glass component conditions

Clean the glass components after each working process to prolong their lifetime. The glass assemblies can be taken out and cleaned manually with water and a commercial cleaning agent (e.g. mild soap solution) or in an ultrasonic bath. Visibly check for damages at all the glass components subsequently.

Note

- *It is recommended to clean all glass components in use.*
- *Regularly check the glassware components for damage and use only glassware in perfect condition, i.e. glassware without cracks or stars.*

7.3.1 Sample tubes

Do not use cold water to cool down the sample tubes after digestion. The resulting temperature shock might lead to tension and cracks in the glass.

Make sure that the sample tubes are placed as illustrated in the laboratory washing instrument (see drawing). Thus the tubes will not be damaged during washing.

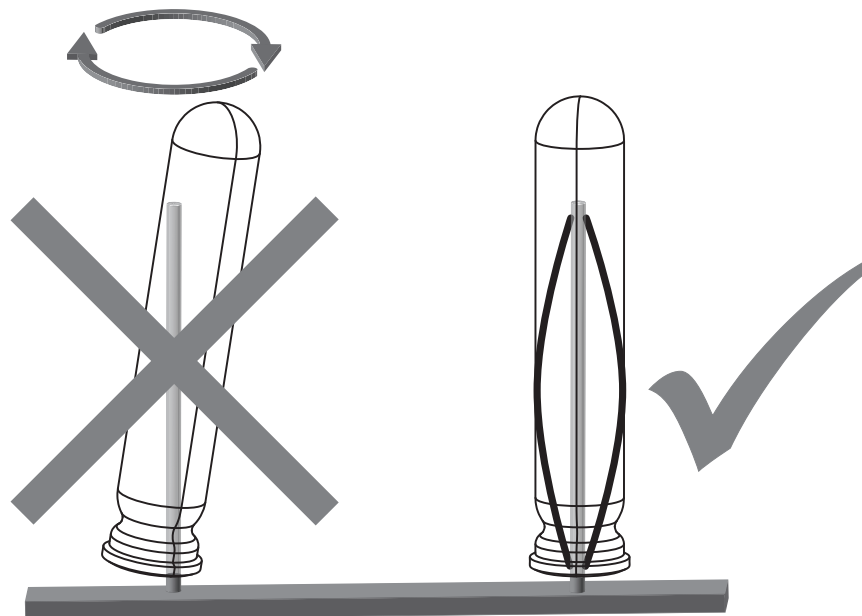

7.4 Sealing system

Regularly clean and inspect the sealings for possible damage as described in section 7.2. The sealings are expendable items and must be replaced if they are damaged or no longer seal properly.

NOTICE	
	<p>Risk of sealing damage by lubricants or sharp objects.</p> <ul style="list-style-type: none"> • Do not lubricate sealings • Do not bring sealings in contact with sharp objects • Use ethanol or soapy water as detergent only

To prolong the lifetime of the seals, rinse them routinely with water and always when there has been

the possibility of unwanted sample contamination (foaming or boiling retardation). Afterwards dry the cleaned seals with a soft cloth.

7.5 Rack system

To prolong the lifetime of the racks, rinse them with water thoroughly to remove possible acid residues. Subsequently, clean the racks with non-abrasive cleaning agents (e.g. soapy water).

7.5.1 300ml sample tube support spring

The 300ml tube rack is equipped with six sample tube support assemblies. Each assembly includes a circular spring and a black plastic retaining ring with notches. Three of six notches are equipped with small brackets – to release the spring gently squeeze the retaining ring and lift it off the rack. For installation simply push the ring and spring assembly in.

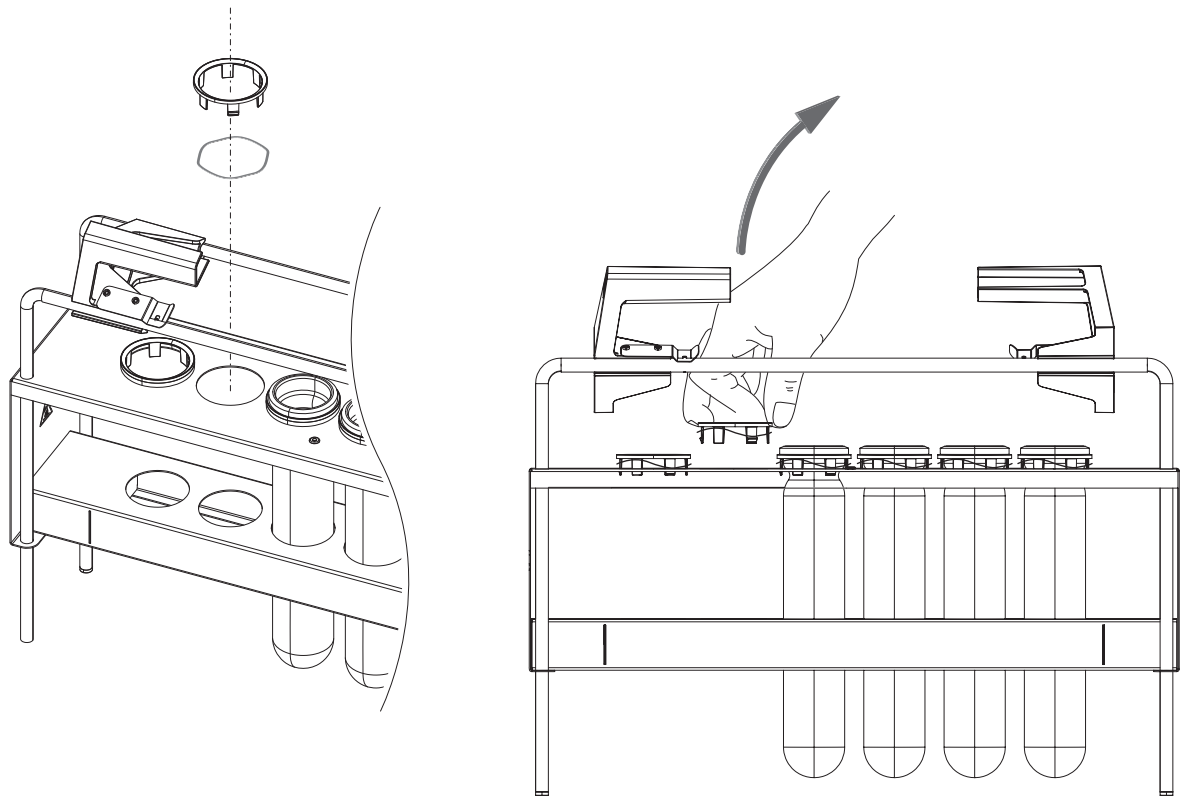

Note

- *Keep the springs clean to avoid corrosion.*
- *Regularly check the spring force for signs of wearing. Inserted glasses must not squeeze the spring assembly significantly.*
- Exchange 'Set circular spring and holder' (order no. 11055984) in case of leakages between sample tube and suction module.

7.5.2 500 ml sample tube support spring

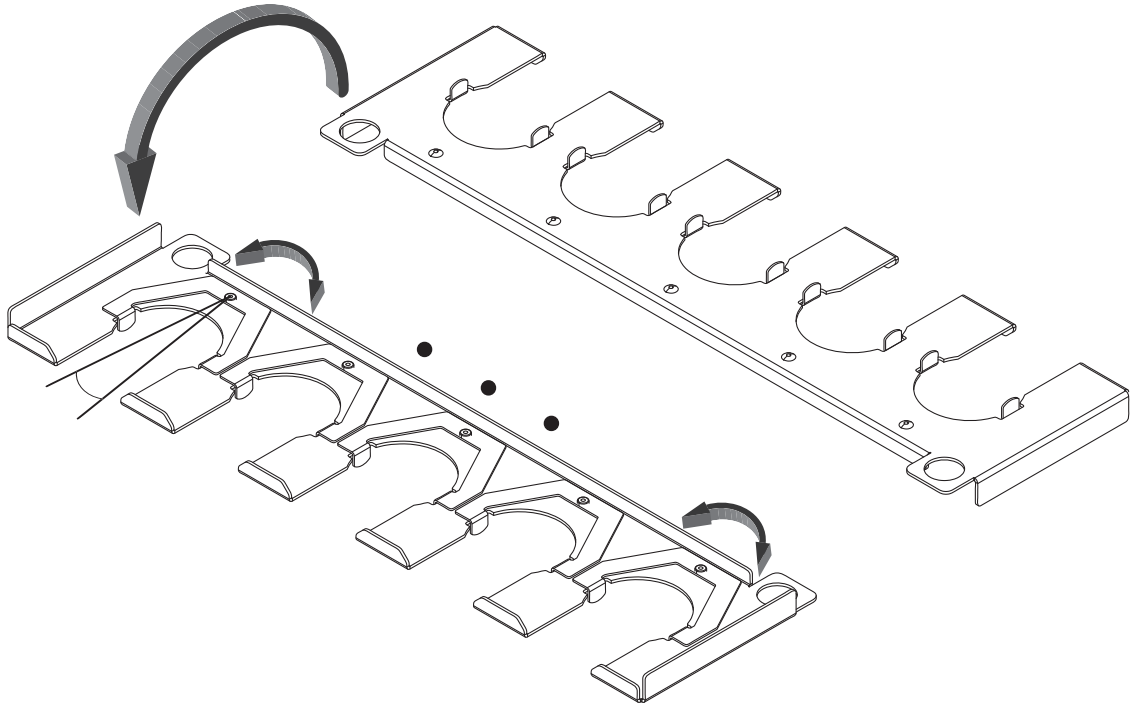

The 500 ml tube rack is equipped with a tube holder containing five sample tube support springs. Each flat spring must be freely rotatable by a small amount. If swivelling is not possible, exchange the rake!

Note

- *Rinse the tube holder with water after use to avoid corrosion.*
- *Store it dry and clean after use.*

7.6 Display cover

The display cover is equipped with double-faced adhesive tape. If it is strongly contaminated or damaged, replace it with a new one.

8 Troubleshooting

This chapter helps to resume operation after a problem has occurred with the instrument which does not require special technical training. It lists possible occurrences, their probable cause and suggests how to remedy the problem.

The troubleshooting table below lists possible malfunctions and errors of the instrument. The operator is enabled to correct some of those problems or errors by him/herself. For this, appropriate corrective measures are listed in the column "Remedy".

8.1 Malfunctions and their remedy

Info/error numbers and messages and their corrective measures		
Info/error number	Message	Measure
1	You cannot delete the actual method!	Do not try to delete the current method.
4	You have changed an existing method. Overwrite method?	Overwrite the existing method or store the new parameters under a new name.
5	The method list is full! You have to delete some methods.	Delete some methods and add new methods.
6	Heating finished!	Heating process is finished, take racks in cooling position. Press OK to confirm it.
7	Digestion done!	Digestion and cooling is finished. Press OK to confirm it.
8	The actual temperature is higher than the preheating temperature. Start Step 1?	Choose "Yes" to start with a higher temperature. Choose "No" to wait until the system is cooled down to the preheating temperature.
9	EEPROM for Device Data defect or missing!	Contact the Buchi customer service.
10	EEPROM for Print Data defect!	Contact the Buchi customer service.
11	Temperature sensor 1.	Contact the Buchi customer service.
12	Temperature sensor 2.	Contact the Buchi customer service.
15	Electronic device too hot	Contact the Buchi customer service.
16	Supply voltage out of range	Make sure that the mains voltage corresponds to the type plate. If yes, contact the Buchi customer service.
17	Unit runs in Demo Mode.	Switch off the Demo Mode in the Settings.
18	Restart from Watchdog.	No corrective measure needed.
19	Delete "XY"?	Confirmation for deletion of a method needed.

Malfunctions and their remedy		
Malfunction	Possible cause	Remedy
System does not heat	No voltage	Insert mains plug, examine plug for damage, check power switch
	Mains switch is turned off	Switch must light up green, when system is powered up
	Fuse has been activated	Exchange fuse(s), see section 8.3
	Heating elements are defective	Contact Buchi customer service to replace defective component(s)
	Heating elements are overheated— overtemperature safety switch is activated	Contact Buchi customer service for repair of defective component(s)
Fumes are escaping from the suction module or its assemblies into the fume hood	<ul style="list-style-type: none"> • Scrubber or water jet pump not switched on or functioning correctly • Defective or clogged sealing, glassware or tubes 	<ul style="list-style-type: none"> • Stop the digestion process • Check and clean all parts • See manuals of the Scrubber / water jet pump on how to increase suction power

Malfunctions or errors which are not listed in the table are to be corrected by a Buchi trained technical engineer who has access to the official service manuals. In this case, please refer to your local Buchi customer service agent.

8.2 Diagnostics

The K-439 software enables the user to carry out a service test (OQ) and to view actors, sensors, operating hours and unit information.

To open the Diagnostics menu select Main Menu > Diagnostics. The following screen appears:

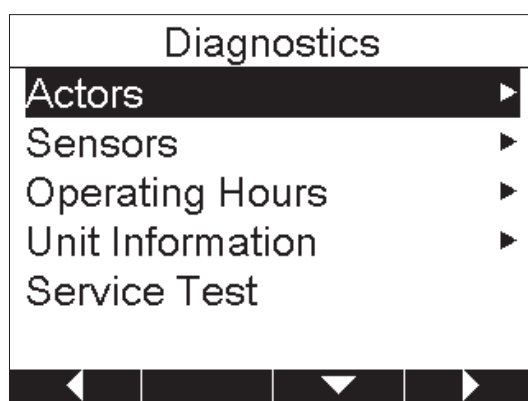

8.2.1 Actors

This submenu enables the user to view the heating output of the heaters and the status of the Scrubber B-414 and the backlight:

- Heaters: xx % xx °C
- Scrubber: On/Off
- Backlight: On/Off

8.2.2 Sensors

This submenu enables the user to check the functionality of the following sensors:

- Voltage: xx VAC
- Triac temp.: xx °C
- LCD temp.: xx °C
- Temperature sensor 1: xx °C
- Temperature sensor 2: xx °C

8.2.3 Operating Hours

This submenu enables the user to view the operating hours of:

- Power-on Time: xx h
- Heating Time: xx h
- Row Left: xx h
- Row Right: xx h

8.2.4 Unit Information

This submenu indicates some unit information:

- Version Firmware
- Test Date Print
- Version Print
- Max. Temperature Triac
- Max. Temperature LCD



8.2.5 Service Test

The service test enables the user or engineer to carry out a functionality test, which is also needed for the Operational Qualification (OQ).

8.3 Device fuses

To change a defective fuse proceed as follows

- Switch off the SpeedDigester and unplug the power cord.
- To access the glass fuses on the rear side use a flat screwdriver blade.
 - ↳ Turn it approx. 5 turns anticlockwise to free the insert.
 - ↳ Take out the insert together with the fuse.
- Replace the defective fuse (see technical data for fuse type!)
- Reconnect the SpeedDigester to the mains.

 	<p>! WARNING</p> <p>Death or serious burns by electric current.</p> <ul style="list-style-type: none"> • Switch off the instrument • Disconnect the power cord and prevent unintentional restart before removing the fuse holder • Do not touch the fuse or the fuse holder with wet hands • Exchange defective fuses only with the original type
--	--

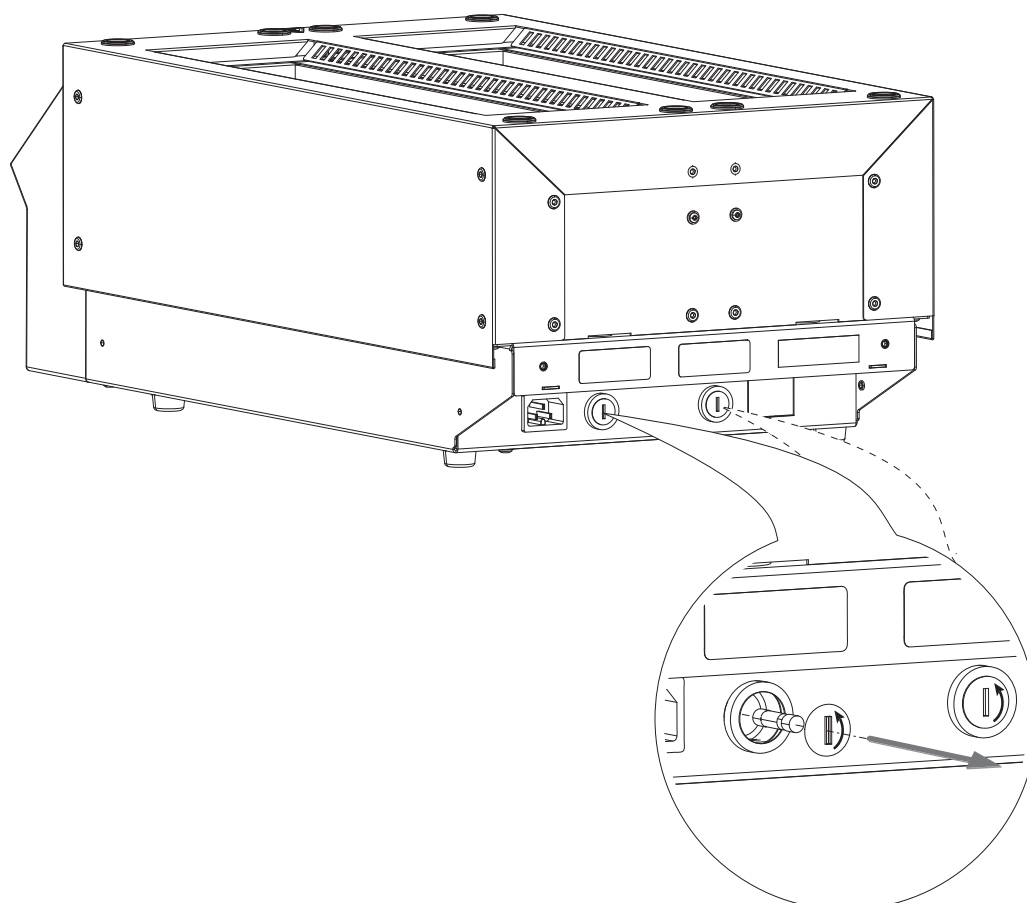

Note



Device fuses may blow occasionally due to voltage peaks under high system load. When fuses burn frequently, inform your customer service!

9 Shutdown, storage, transport and disposal

This chapter instructs how to shut down and to pack the instrument for storage or transport. Specifications for storage and shipping conditions can also be found listed here.

9.1 Storage and transport

Switch off the instrument and remove the power cord. To disassemble the SpeedDigester K-439 follow the installation instructions in section 5 in reverse order. Remove all liquids and dusty residues before packaging the instrument.

	<p>! WARNING</p> <p>Death or serious poisoning by contact or incorporation of harmful substances.</p> <ul style="list-style-type: none"> • Wear safety goggles • Wear safety gloves • Wear a laboratory coat • Clean the instrument and all accessories thoroughly to remove possibly dangerous substances • Do not clean dusty parts with compressed air • Store the instrument and its accessories at a dry place in its original packaging
	<p>! CAUTION</p> <p>Risk of minor or moderate injury by heavy weight of the instrument with accessories.</p> <ul style="list-style-type: none"> • Consult a second person to transport the instrument set • Do not drop the instrument or its transport box • Place the instrument on a stable, even and vibration-free surface • Keep limbs out of crushing zone

9.2 Disposal

For instrument disposal in an environmentally friendly manner, a list of materials is given in chapter 3.3. This helps to ensure that the components can be separated and recycled correctly by a specialist for disposal.

For disposal of liquids and consumables such as catalyst or acid, see data sheets of these chemicals!

You have to follow valid regional and local laws concerning disposal. For help, please contact your local authorities!

Note

When returning the instrument to the manufacturer for repair work, please copy and complete the health and safety clearance form on the following page and enclose it with the instrument.

Health and Safety Clearance

Declaration concerning safety, potential hazards and safe disposal of waste.

For the safety and health of our staff, laws and regulations regarding the handling of dangerous goods, occupational health and safety regulations, safety at work laws and regulations regarding safe disposal of waste (e.g. chemical waste, chemical residues or solvents) require that this form must be completed, signed and enclosed to every return shipment of equipment or defective parts.

Instruments or parts will not be accepted if this declaration is not present.

Equipment

Model:

Part/Instrument no.:

1.A Declaration for non dangerous goods

We assure that the returned equipment:

- is unused and new.
- has not been exposed to toxic, corrosive, biologically active, explosive, radioactive or other dangerous matters. No hazard emanates from the device!
- is free of contamination (e.g. that chemicals, solvents or residues of pumped media have been drained prior to shipment). No hazard emanates from the device!



1.B Declaration for dangerous goods

Exhaustive list of dangerous substances the equipment has been exposed to:

Chemical, substance	Danger classification

We assure that:

- all hazardous substances (e.g. toxic, corrosive, biologically active, explosive, radioactive etc.) which have been processed or been in contact with the equipment are listed above.
- the equipment has been cleaned, decontaminated and is free of transmissible agents such as hazardous fungi, bacteria, viruses etc. If sterilization is applicable, all in- and outlets of the equipment have been properly sealed the process.

2. Final Declaration

We hereby declare that:

- we know all about the substances which have been in contact with the equipment and all questions have been answered correctly.
- we have taken all measures to prevent potential risks that might emanate from the delivered equipment.
- this document will be attached clearly visible and securely to the outside of the transport box.

Company name or stamp: _____

Place, date: _____

Name (print), job title (print): _____

Signature: _____

10 Spare parts

This chapter lists spare parts, accessories and options including their ordering information. Only order spare parts and consumables from Buchi to maintain the warranty status and to assure best performance and reliability of the system and affected components. Any modifications to the spare parts used are only allowed with the prior written permission of the manufacturer.

Always state the product designation, instrument serial and part numbers for warranty clearance when ordering spare parts!

10.1 Spare parts, optional accessories and consumables



Spare parts	
Description	Order no.
Mains cable, CH-type	10021
Mains cable, DE-type	10029
Mains cable, GB-type	17833
Mains cable, US-type	33756
Mains cable, AU-type	17834
Operation Manual, English	11593351
Operation Manual, German	11593352
Operation Manual, French	11593353
Operation Manual, Italian	11593354
Operation Manual, Spanish	11593355
Connector to suction module (2 pcs.)	11055367
2× sealing EPDM 12,5 * 8	11055897
O-ring FKM 11 * 2	11055910
Rubber plug	11056016
EPDM hose, 1.5 m, 8 mm	11056005
Plug for rack pedestal	11055359
Magnetic bracket	11056231

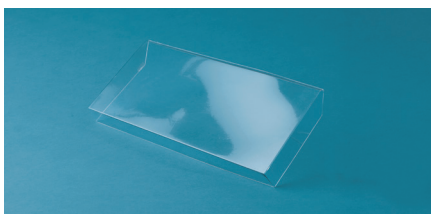
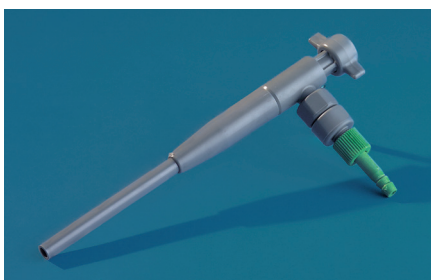

Optional parts

Description	Order no.
Scrubber B-414 with condenser, 230V	037882
Scrubber B-414 with condenser, 120V	037883
Scrubber B-414 with condenser, 100V	037884
Scrubber connection cable	014738

Condensate bottle 4L for Scrubber B-414	048668
---	--------

Water jet pump	02913
----------------	-------

Display cover	11055329
---------------	----------

IQ/OQ set, complete	11056167
---------------------	----------

IQ/OQ set, documents only	11056279
---------------------------	----------

OQ sensor adapter	11055144
-------------------	----------

OQ test plug for Scrubber interface	11055898
-------------------------------------	----------

Repeating OQ	11056253
--------------	----------

Preheat cover	11055842
---------------	----------

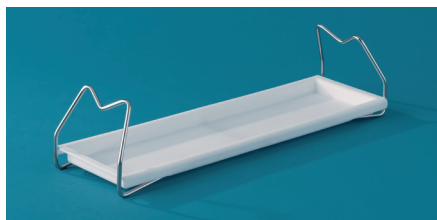
**Optional parts**

Description	Order no.
Stand with drip tray	11055216

Digestion rod (set of 10)	043087
---------------------------	--------

Consumables

Description	Order no.
Kjeldahl tablets (Hg/Se-free), 250 pcs.	028765

11 Declarations and requirements

11.1 FCC requirements (for USA and Canada)

English:

This equipment has been tested and found to comply with the limits for a Class A digital device, pursuant to both Part 15 of the FCC Rules and the radio interference regulations of the Canadian Department of Communications. These limits are designed to provide reasonable protection against harmful interference when the equipment is operated in a commercial environment.

This equipment generates, uses and can radiate radio frequency energy and, if not installed and used in accordance with the instruction manual, may cause harmful interference to radio communications. Operation of this equipment in a residential area is likely to cause harmful interference in which case the user will be required to correct the interference at his own expense.

Français:

Cet appareil a été testé et s'est avéré conforme aux limites prévues pour les appareils numériques de classe A et à la partie 15 des réglementations FCC ainsi qu'à la réglementation des interférences radio du Canadian Department of Communications. Ces limites sont destinées à fournir une protection adéquate contre les interférences néfastes lorsque l'appareil est utilisé dans un environnement commercial.

Cet appareil génère, utilise et peut irradier une énergie à fréquence radioélectrique, il est en outre susceptible d'engendrer des interférences avec les communications radio, s'il n'est pas installé et utilisé conformément aux instructions du mode d'emploi. L'utilisation de cet appareil dans les zones résidentielles peut causer des interférences néfastes, auquel cas l'exploitant sera amené à prendre les dispositions utiles pour palier aux interférences à ses propres frais.

BUCHI Affiliates:

Europe

Switzerland/Austria

BÜCHI Labortechnik AG
CH – 9230 Flawil
T +41 71 394 63 63
F +41 71 394 64 64
buchi@buchi.com
www.buchi.com

Italy

BUCHI Italia s.r.l.
IT – 20010 Cornaredo (MI)
T +39 02 824 50 11
F +39 02 575 12 855
italia@buchi.com
www.buchi.com/it-it

Benelux

BÜCHI Labortechnik GmbH
Branch Office Benelux
NL – 3342 GT Hendrik-Ido-Ambacht
T +31 78 684 94 29
F +31 78 684 94 30
benelux@buchi.com
www.buchi.com/bx-en

Russia

BUCHI Russia/CIS
Russia 127287 Moscow
T +7 495 36 36 495
russia@buchi.com
www.buchi.com/ru-ru

France

BUCHI Sarl
FR – 94656 Rungis Cedex
T +33 1 56 70 62 50
F +33 1 46 86 00 31
france@buchi.com
www.buchi.com/fr-fr

United Kingdom

BUCHI UK Ltd.
GB – Oldham OL9 9QL
T +44 161 633 1000
F +44 161 633 1007
uk@buchi.com
www.buchi.com/gb-en

Germany

BÜCHI Labortechnik GmbH
DE – 45127 Essen
T +800 414 0 414 0 (Toll Free)
T +49 201 747 49 0
F +49 201 747 49 20
deutschland@buchi.com
www.buchi.com/de-de

Germany

BÜCHI NIR-Online
DE – 69190 Walldorf
T +49 6227 73 26 60
F +49 6227 73 26 70
nir-online@buchi.com
www.nir-online.de

America

Brazil

BUCHI Brasil Ltda.
BR – Valinhos SP 13271-200
T +55 19 3849 1201
F +55 19 3849 2907
brasil@buchi.com
www.buchi.com/br-pt

USA/Canada

BUCHI Corporation
US – New Castle, DE 19720
T +1 877 692 8244 (Toll Free)
T +1 302 652 3000
F +1 302 652 8777
us-sales@buchi.com
www.buchi.com/us-en

Asia

China

BUCHI China
CN – 200233 Shanghai
T +86 21 6280 3366
F +86 21 5230 8821
china@buchi.com
www.buchi.com/cn-zh

India

BUCHI India Private Ltd.
IN – Mumbai 400 055
T +91 22 667 75400
F +91 22 667 18986
india@buchi.com
www.buchi.com/in-en

Indonesia

PT. BUCHI Indonesia
ID – Tangerang 15321
T +62 21 537 62 16
F +62 21 537 62 17
indonesia@buchi.com
www.buchi.com/id-in

Japan

Nihon BUCHI K.K.
JP – Tokyo 110-0008
T +81 3 3821 4777
F +81 3 3821 4555
nihon@buchi.com
www.buchi.com/jp-ja

Korea

BUCHI Korea Inc.
KR – Seoul 153-782
T +82 2 6718 7500
F +82 2 6718 7599
korea@buchi.com
www.buchi.com/kr-ko

Malaysia

BUCHI Malaysia Sdn. Bhd.
MY – 47301 Petaling Jaya,
Selangor
T +60 3 7832 0310
F +60 3 7832 0309
malaysia@buchi.com
www.buchi.com/my-en

Singapore

BUCHI Singapore Pte. Ltd.
SG – Singapore 609919
T +65 6565 1175
F +65 6566 7047
singapore@buchi.com
www.buchi.com/sg-en

Thailand

BUCHI (Thailand) Ltd.
TH – Bangkok 10600
T +66 2 862 08 51
F +66 2 862 08 54
thailand@buchi.com
www.buchi.com/th-th

BUCHI Support Centers:

South East Asia

BUCHI (Thailand) Ltd.
TH-Bangkok 10600
T +66 2 862 08 51
F +66 2 862 08 54
bacc@buchi.com
www.buchi.com/th-th

Middle East

BÜCHI Labortechnik AG
UAE – Dubai
T +971 4 313 2860
F +971 4 313 2861
middleeast@buchi.com
www.buchi.com

Latin America

BUCHI Latinoamérica S. de R.L. de C.V.
MX – Mexico City
T +52 55 9001 5386
latinoamerica@buchi.com
www.buchi.com/es-es

We are represented by more than 100 distribution partners worldwide.
Find your local representative at: www.buchi.com